



# Pictorial Parts Manual

Part # PWT035

*Effective Date 1 July, 2008*  
*Revision 01*

Prowash Australia Pty Ltd  
13 – 15 Flight Drive TULLAMARINE VIC 3043  
service@prowash.com.au [www.prowash.com.au](http://www.prowash.com.au)



**SECTION 1**  
**Self Serve Bay Equipment**

**SECTION 2**  
**Self Serve Pump Stand**

**SECTION 3**  
**Water Treatment**

**SECTION 4**  
**Water Heater**

**SECTION 5**  
**Air Compressor**

**SECTION 6**  
**Mains Water Re-Pressure System**

**SECTION 7**  
**Vacuums**

**SECTION 8**  
**Fragrance Machine**

**SECTION 9**  
**Change Machine**

**SECTION 10**  
**Vending Machines**

**SECTION 11**  
**SuperSat**

**SECTION 12**  
**Bonus Time**



## SECTION 1

# Self Serve Bay Equipment

- Touch Select Bay Controller
- High Pressure Gun, Swivel & Hose
- Foam Brush, Swivel & Hose
- Wash Bay Booms
- Mat Hanger
- Foam Brush Assembly
- Bay Manifold & Connections
- Wash Bay Signage



**Microcoin**

**GinSan**



# Touch Select Bay Controller



ITEM	PART #	DESCRIPTION
1	DH40102	Touch Select S/Steel Surround 40mm Wide
2	PW60001	Touch Select Timer
3	DH40100	Touch Select Hull (Hinged)
4	DH40096	Touch Select Hull (Non Hinged) (Not Shown)
5	DH77748	Touch Select Clear Lens (Between Door and Decal)
6	DH21819	Touch Select Door Decal (Hinged)
7	DH21820	Touch Select Door Decal (Non Hinged) (Not Shown)
8	DH23016A	Touch Select Lock (F310)
9	DH23016B	Touch Select Lock (F320)
10	DH40079	Touch Select Coin Tray (Not Shown)
11	DH40078	Touch Select Safe Door
12	DH40077	Touch Select Safe Hull
13	DH23018	Lock, American 2000

# Touch Select Bay Controller – Internal View

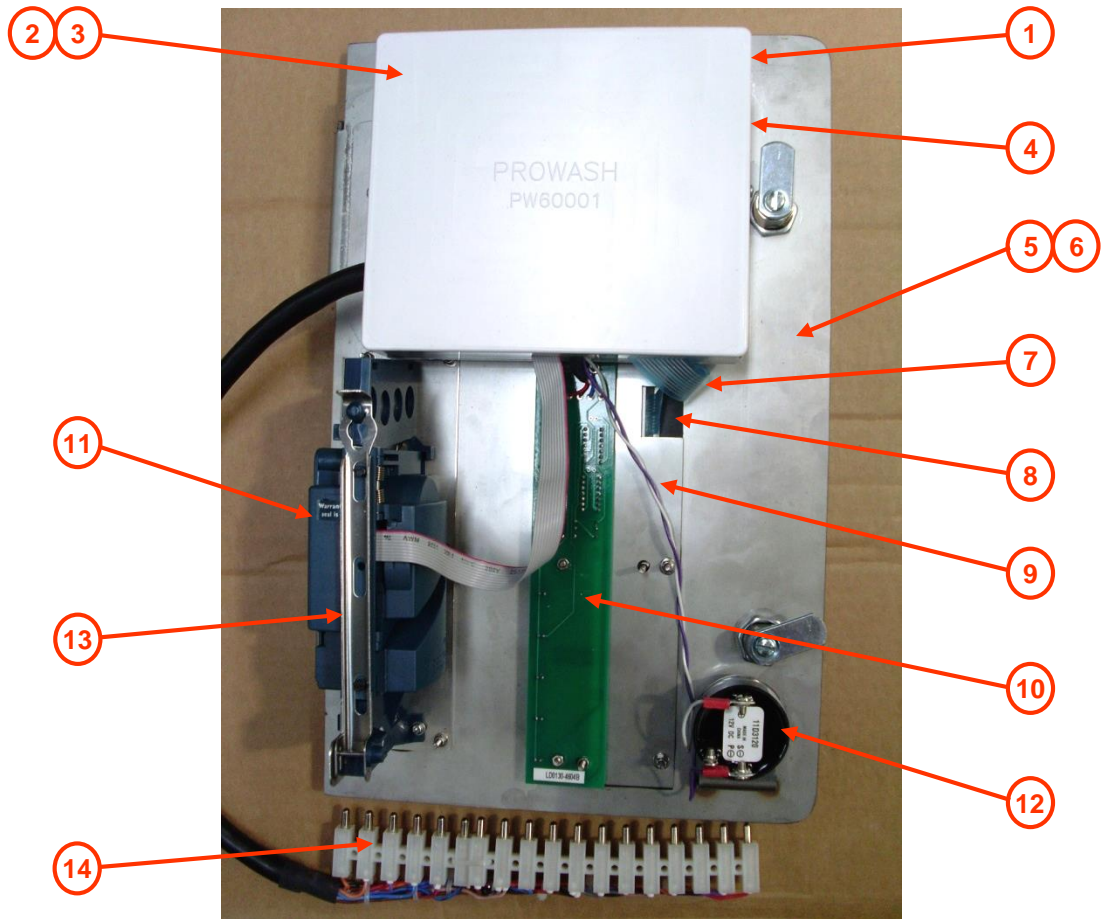

ITEM	PART #	DESCRIPTION
1	DH77751	Touch Select Front Lens (Not Shown)
2	PW60001	Touch Select Timer
3	PW60001ENC	Touch Select Timer Plastic Enclosure
4	DH77750	Touch Select Rear Lens Display (Not Shown)
5	DH32301	Touch Select Hinged Door Only
6	DH32305RAW	Touch Select Non Hinged Door Only (Not Shown)
7	PW99995	Touch Select 10 Way Keypad
8	DH77749	Touch Select Rubber Pad
9	DH77757	Touch Select Hold Down Plate
10	PW60005	Touch Select Light Assembly
11	MC93367810	Microcoin QL Coin Acceptor (Top Entry)
12	DH19380	Touch Select Beeper
13	MC54020000	Microcoin QL Coin Acceptor Bracket
14	PW60010	Touch Select Wire Loom



## High Pressure Gun, Swivel & Hose

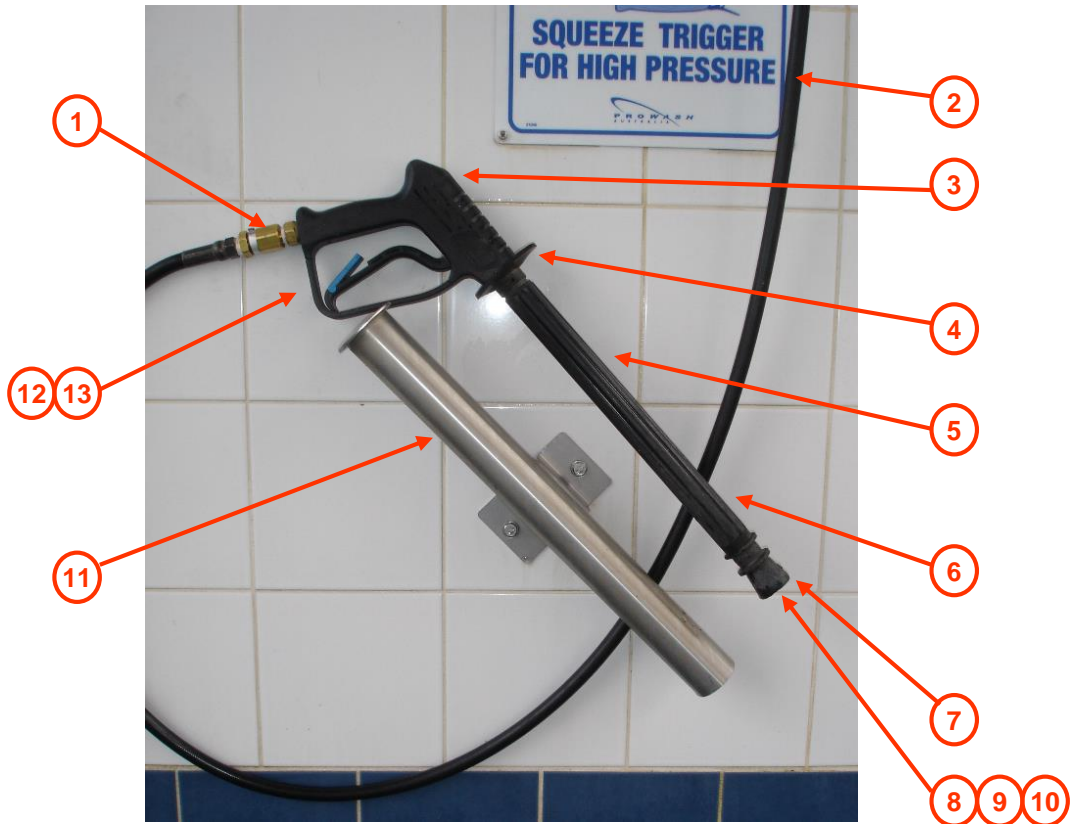

ITEM	PART#	DESCRIPTION
1	DH22323	Swivel, High Pressure Gun & Hose 3/8"
2	DH22290	Hose, High Pressure 4 Mts (MxF)
3	DH17681	Gun Handle With Weep (Vega)
4	DH22046	Gun Handle Protector
5	DH22030	Lance S/Steel 1/4" x 14" (Not Shown)
6	DH22003	Lance Protector 14"
7	DH22005	Nozzle Protector - Black
8	DH22472	Spray Nozzle 2506 No Vein (Not Shown)
9	DH22474	Spray Nozzle 2507 With Vein (Not Shown)
10	DH22476	Spray Nozzle 2505 No Vein (Not Shown)
11	DH40394	Gun Holder S/Steel
12	DH31057	High Pressure Gun Complete with 2507 Nozzle
13	DH31058	High Pressure Gun Complete with 2506 Nozzle (Water Saver)

## Foam Brush, Swivel & Hose



ITEM	PART#	DESCRIPTION
1	DH22509	Hog Hair Brush
2	DH40405	J-Hook S/Steel
3	PW99804	Sign, Rinse Foam Brush (300mm x 300mm)
4	DH22331	Swivel, Foam Brush 3/8"
5	DH24546	Elbow, Brass 3/8" M/NPT x 3/8" F/NPT
6	DH24543	Hose Protector, Foam Brush 3/8"
7	DH22104	Hose, Foam Brush 14ft x 3/8" MxF (Push-loc)
8	DH22508	Foam Brush Handle Aluminium

**Please note hose fitting to boom, 3/8" Female Swivel (DH24450) and 3/8" Barb (DH24444)**

# Wash Bay Booms

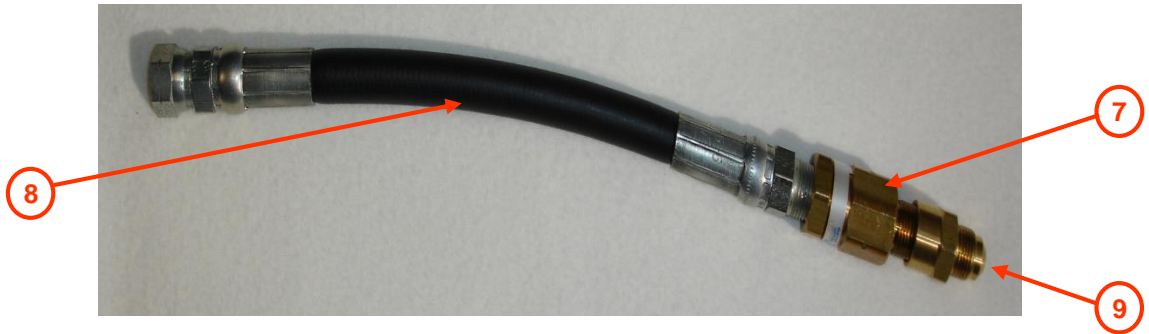
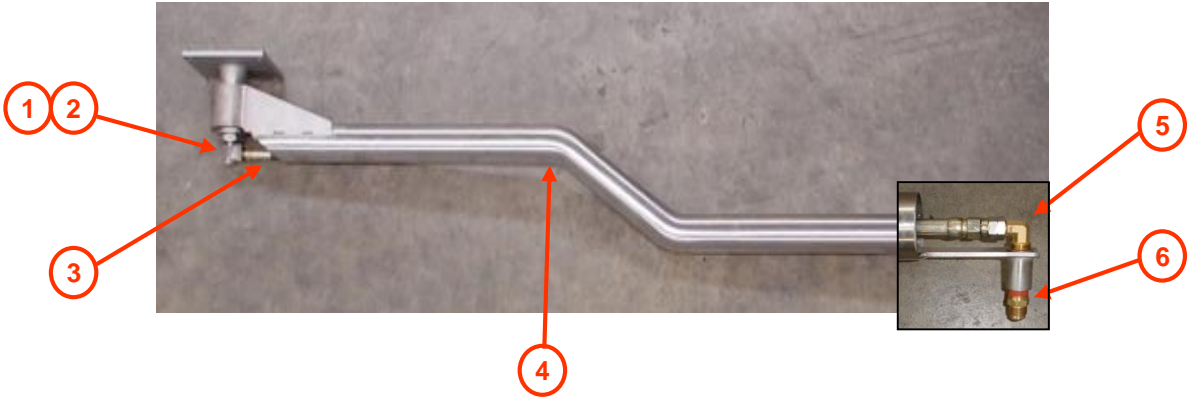

ITEM	PART#	DESCRIPTION
1	DH22297	Swivel, 90 Degree (Mosmatic)
2	DH22299	Swivel Kit, 90 Degree (Mosmatic) (Not Shown)
3	PW99904	Hose, High Pressure 3/8" Z Boom 3/8"M x 3/8" F/NPT
4	DH99100	Complete Z Boom 1700mm
5	DH24211	Elbow Flare, 3/8" MFL/NPT x 3/8" M/NPT 90 Degree
6	DH24177	Adapter Flare, 3/8" MFL/NPT x 3/8" M/NPT
7	DH22323	Swivel, Gun & Hose 3/8"
8	DH31055	Hose, 3/8" High Pressure Swivel Saver 12" MxF
9	DH24154	Adapter Flare 3/8" MFL/NPT x 3/8" F/NPT

**Please note before ordering Z boom be sure you check the length of boom and the length of the shaft as we have 2 lengths available depending on bay size.**

# Mat Hanger

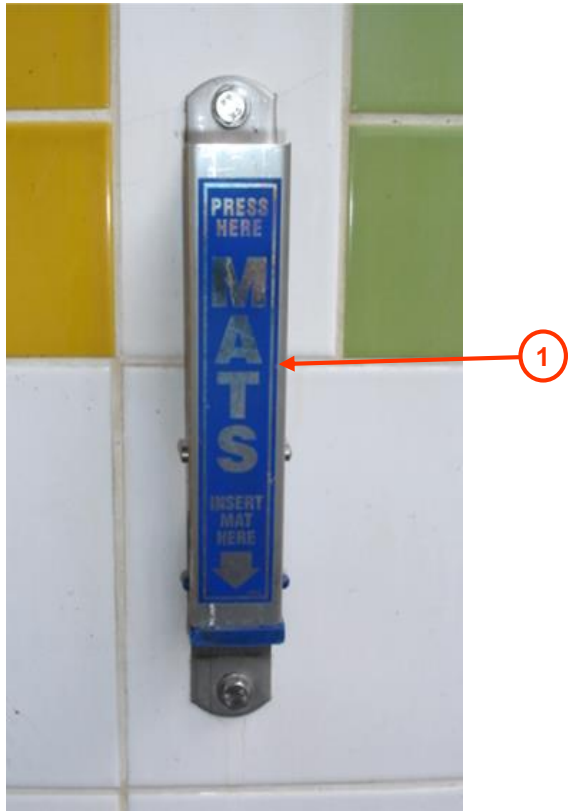

ITEM	PART#	DESCRIPTION
1	DH40299	Mat Hanger S/Steel
2	DH40298	Mat Hanger Spring S/Steel (Not Shown)

# Foam Brush Assembly

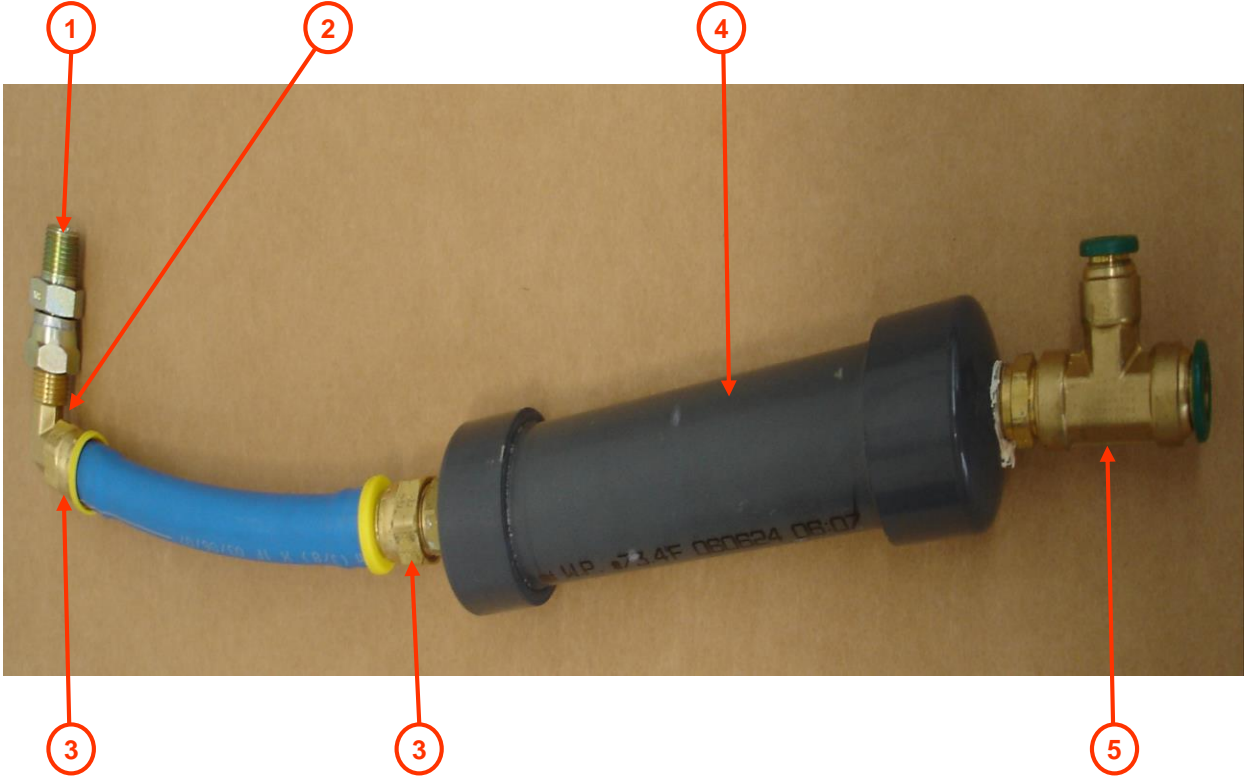

ITEM	PART#	DESCRIPTION
1	140466	Adapter, 3/8" MxF
2	DH24211	Elbow Flare, 3/8" MFL/NPT x 3/8" M/NPT 90 Degree
3	DH24450	Female Swivel, 3/8" (Push-lok)
4	PW99994	Foam Bush Generator (3/8" Fittings)
5	DH14505	Push Tube T, 3/8" x 3/8" x 1/4" M/NPT

# Bay Manifold

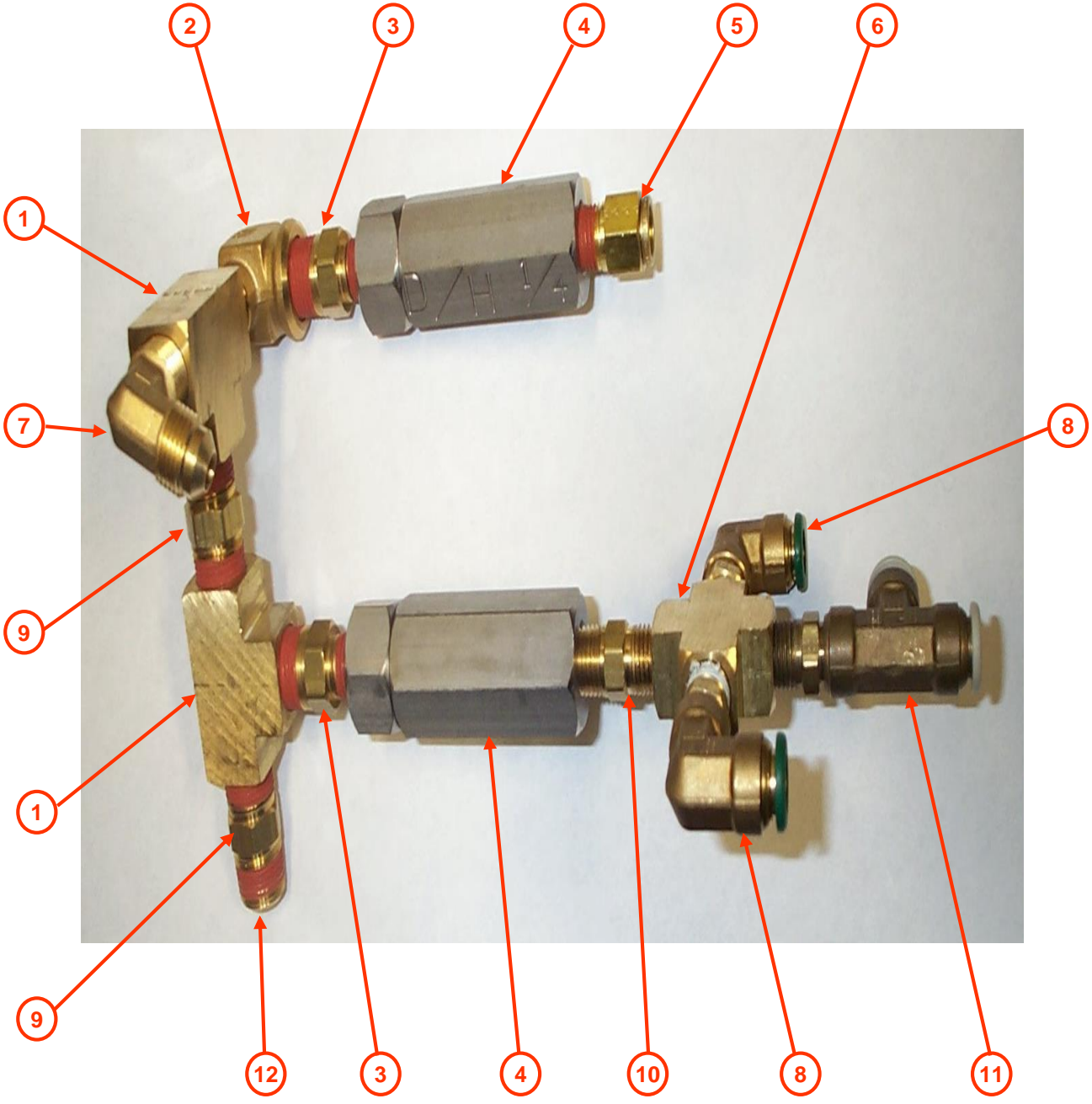

## Bay Manifold - Parts List

ITEM	PART#	DESCRIPTION
1	DH24551	T Female, 3/8" NPT
2	DH24546	Elbow Brass, 3/8" M/NPT x 3/8" F/NPT
3	DH24121	Nipple Reducing Hex, 3/8" x 1/4"
4	DH24921	Check Valve 1/4" FxF S/Steel (2000psi)
5	DH14504	Push Connector, 3/8" T x 1/4" MIP
6	DH24350	Cross Female Brass 1/4"
7	DH24211	Elbow Flare, 3/8" MFL/NPT x 3/8" M/NPT 90 Degree
8	DH14500	Elbow Swivel, 3/8" T x 1/4" NPT
9	DH24493	Nipple Hex, 3/8" M/NPT x 3/8" M/NPT
10	DH24481	Nipple Hex, 1/4" M/NPT x 1/4" M/NPT
11	DH14505	Push Tube T, 3/8" x 3/8" x 1/4" M/NPT
12	140466	Adapter, 3/8" MxF (Not Shown)

# Bay Manifold Connections

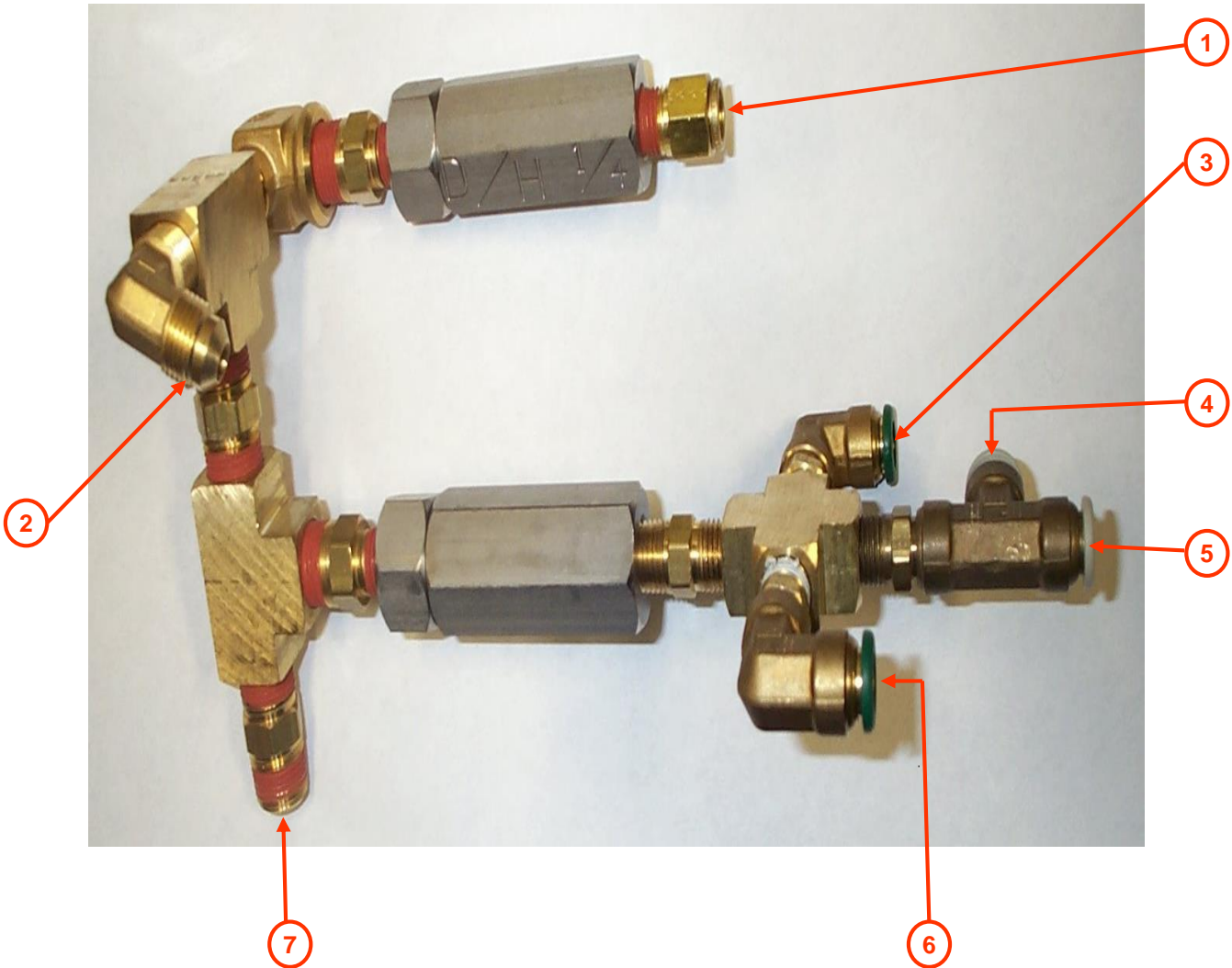

ITEM	DESCRIPTION
1	Spot Free Rinse (Green Tube)
2	High Pressure Water
3	Presoak (Purple / Orange Tube)
4	Air (Blue Tube)
5	Wax (Clear Tube)
6	Tyre / Engine Cleaner (Yellow Tube)
7	High Pressure Boom

**Please Refer to Page 2-10 & 2-11 for Poly Tubing Hose Part Numbers**



# Wash Bay Signage



1



2

ITEM	PART#	DESCRIPTIONS
1	DH21055	Master Menu Board
2	DH31036	Master Menu Strip Kit

# Wash Bay Signage



↑  
①



↑  
②  
③



↑  
⑤



↑  
④

ITEM	PART#	DESCRIPTION
1	PW99804	Sign, Rinse Foam Brush 300mm x 300mm
2	DH21031	Sign, No Bucket Washing 300mm x 300mm
3	DH21032	Sign, No Bucket Washing (Corflute) 300mm x 300mm
4	DH21046	Sign, Squeeze Trigger 300mm x 300mm
5	PW99808	Sign, Under 24hr Surveillance 100mm x 200mm

## SECTION 2

# Self Serve Pump Stand

- Self Serve Pump Stand Overview
- CAT 310 High Pressure Pump
- Hypro High Pressure Pump
- Low Pressure Pump Configurations
- Chemical Mixing Tank
- Hydrominder 506 with Exploded View
- Low Pressure Solenoids
- Water Inlet Solenoids With Reclaim Option
- Electrical Control Cabinet External & Internal Parts





# Self Serve Pump Stand Overview

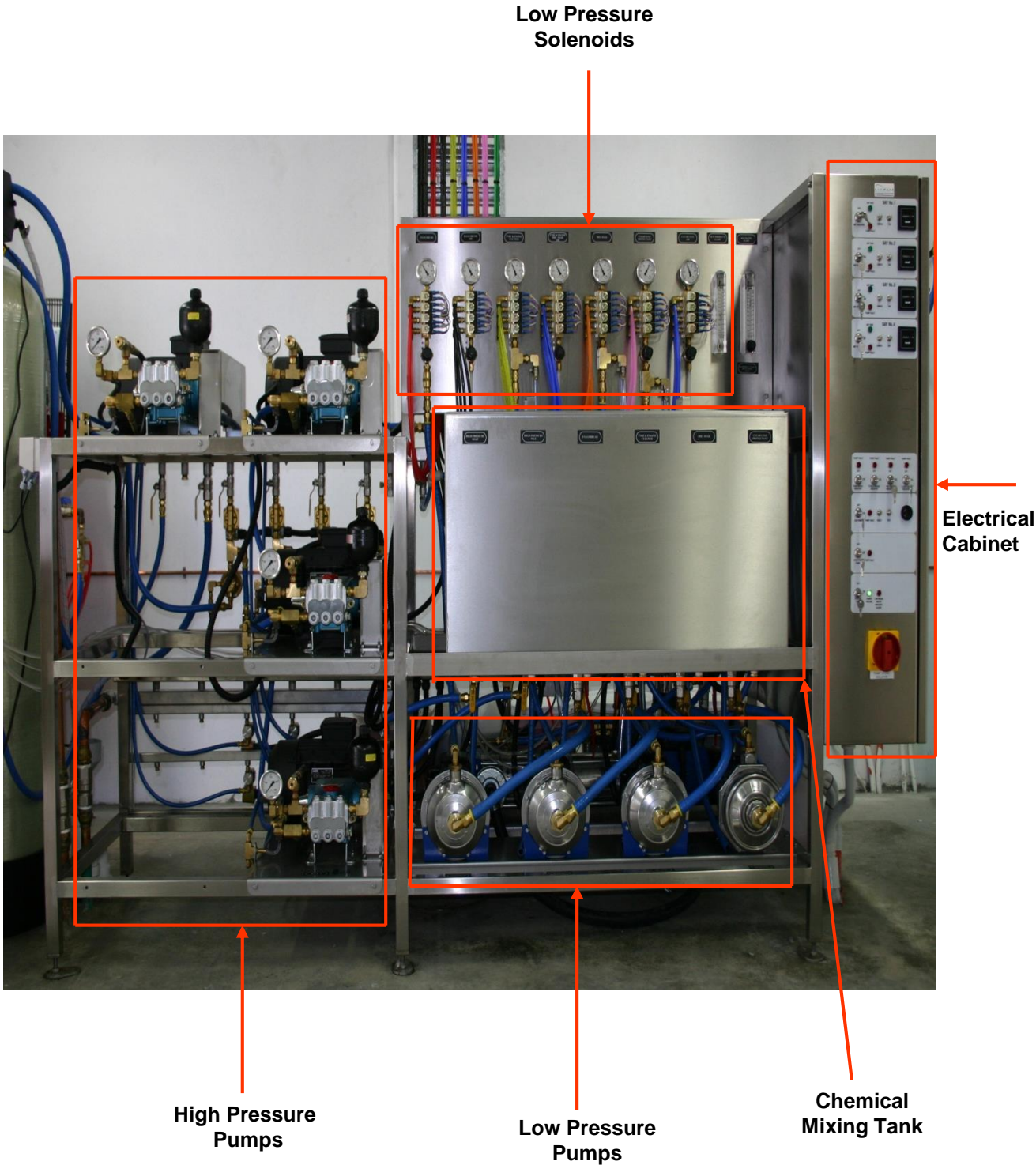

## CAT 310 High Pressure Pump Assembly

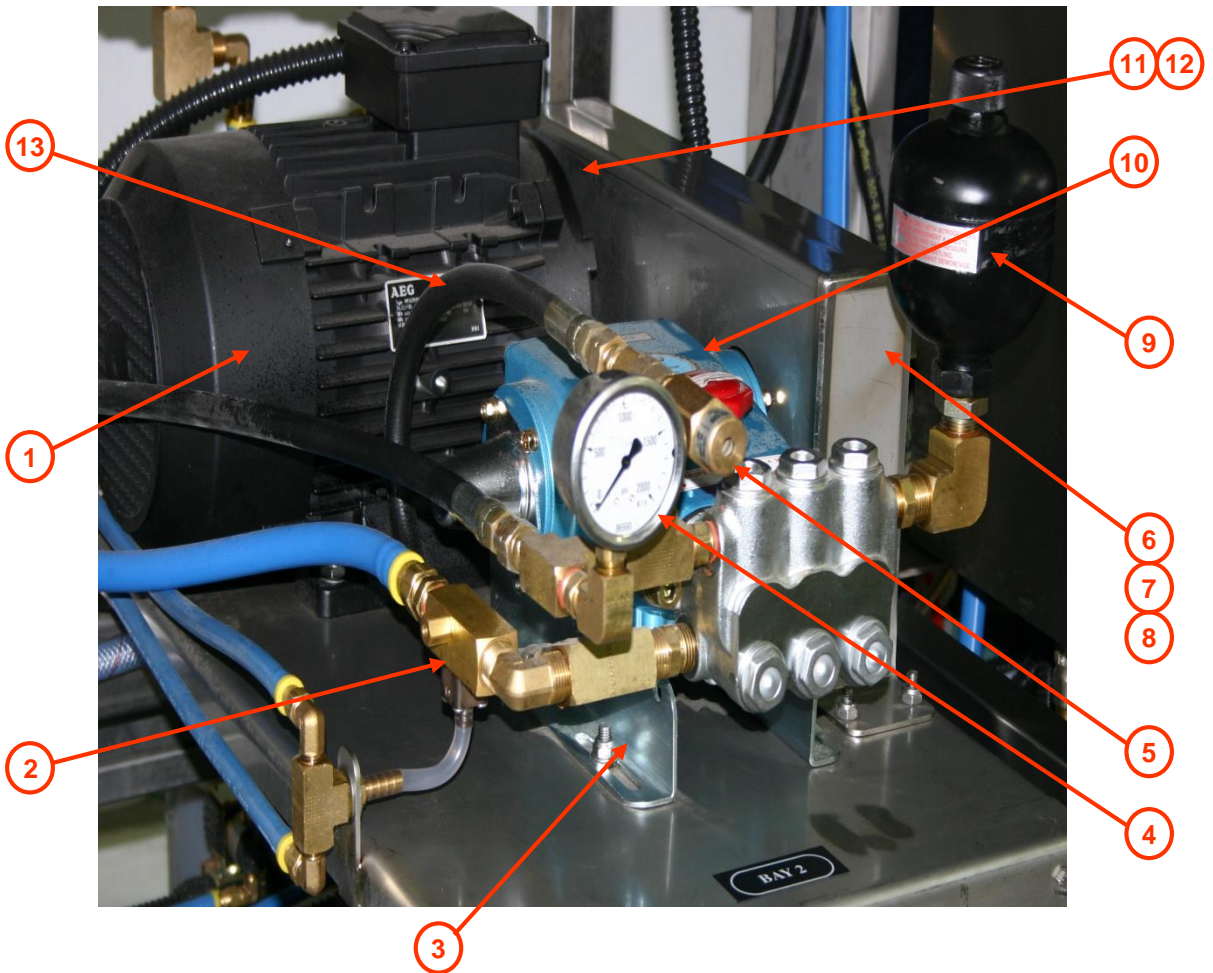

ITEM	PART#	DESCRIPTION
1	PW10042	Motor, 4.0kw 3 Phase (AEG)
2	DH24917	Soap Injector 204-B (Dema)
3	DH81278	Rails, CAT 310 Pump
4	DH24705	Gauge, 0-2000psi
5	DH25098	Pressure Regulator
6	PW10045	Belt Cog, 330H100 (Not Shown)
7	PW10049	Bush, Pulley Pump CAT 310 (Not Shown)
8	PW10048	Pulley, CAT 310 Pump (Not Shown)
9	DH24600	Pulsation Dampener
10	DH81277	Pump, CAT 310
11	PW10046	Pulley, Motor (Not Shown)
12	PW10047	Bush, Pulley Motor 28mm (Not Shown)
13	PW10090	Hose, Bypass High Pressure Pump

## CAT 310 – Spare Parts List

PART#	DESCRIPTION
DH43222	Oil Seal, CAT 310 Crankshaft
DH81277	Pump, CAT 310
DH81278	Rails, CAT 310 Pump
DH87669	O-Ring, Bearing Cover CAT 310
DH88422	Seal Kit, CAT 310
DH88472	Valve Kit, CAT 310
DH88596	Socket Tool, 1/2" Sealcase
DH88597	Seal Case Brass, CAT 310
DH88598	Oil Seal, CAT 310
DH88599	Oil Filler Cap, CAT 310
DH88600	Seal Cover, CAT 310
DH88601	Shaft Protector, CAT 310
DH88602	Ceramic Plunger, CAT 310
DH88604	O-Ring Valve, CAT 310
DH88606	Seal Retainer, CAT 310
DH88607	Adapter Retainer, CAT 310
DH88608	O-Ring Piston, CAT 310
DH88609	Piston Back Up Ring, CAT 310
DH88652	Sight Glass, CAT 310
PW10048	Pulley, CAT 310 Pump
PW10049	Bush, Pulley Pump CAT 310



**Seal case Socket Tool, 1/2" (DH88596)**

Tool to remove brass seal retainer in CAT 310 Pump

## Hypro High Pressure Pump 2414B



**Part # DH81112**



## Hypro Pump – Spare Parts List

PART#	DESCRIPTION
DH80131	Kit Plunger, 2414B Hypro
DH80144	Oil Seal Plunger, Hypro
DH80154	Seal Kit, 2414B C3X Hypro
DH80157	Retainer Ring, 2414BP Hypro
DH80167	Gasket, Sight Glass Hypro
DH80169	Sight Glass, Hypro
DH80171	Valve Kit, 2414B Hypro
DH80189	Seal Shaft, Hypro
DH80190	Gasket End Cover, Hypro
DH80211	Guide Plunger Lower, Hypro
DH81112	Pump, Hypro 2414B C3P 8gpm
DH82000	Seal Kit 2414B-P, Hypro
DH82001	Guide Plunger, Hypro
DH82002	Guide Retainer B-P, Hypro
DH82003	Guide Retainer B-X, Hypro
DH82004	Slinger Ring, Hypro
DH82005	Backup Seal, Hypro
DH82006	O-Ring, Hypro

## 3 Configurations of Low Pressure Pump Systems

### 1 – 3 Bay Self Serve

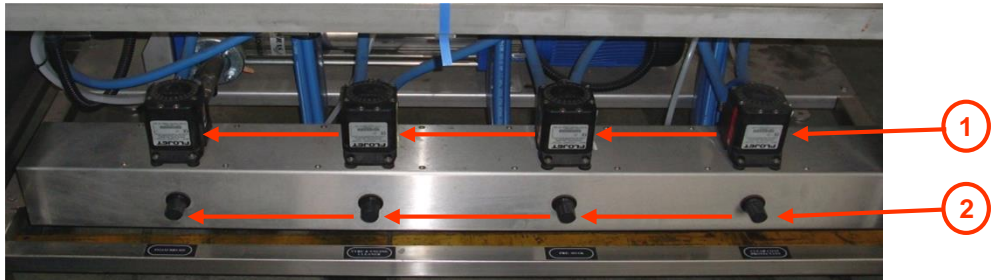

### 4 – 6 Bay Standard Foam Brush Self Serve



### 4 – 6 Bay Self Serve With Tri Colour Foam



ITEM	PART#	DESCRIPTION
1	DH17945	Flojet Air Pump (Viton)
2	DH25093	Pressure Regulator, Air & Water
3	PW10032	Pump, CA-70 / 34-V 3 Phase (Two Stage) Lowara
4	PW10065	Pump, CEA-70 / 5 / AV 3 Phase (Single Stage) Lowara

# Chemical Mixing Tank

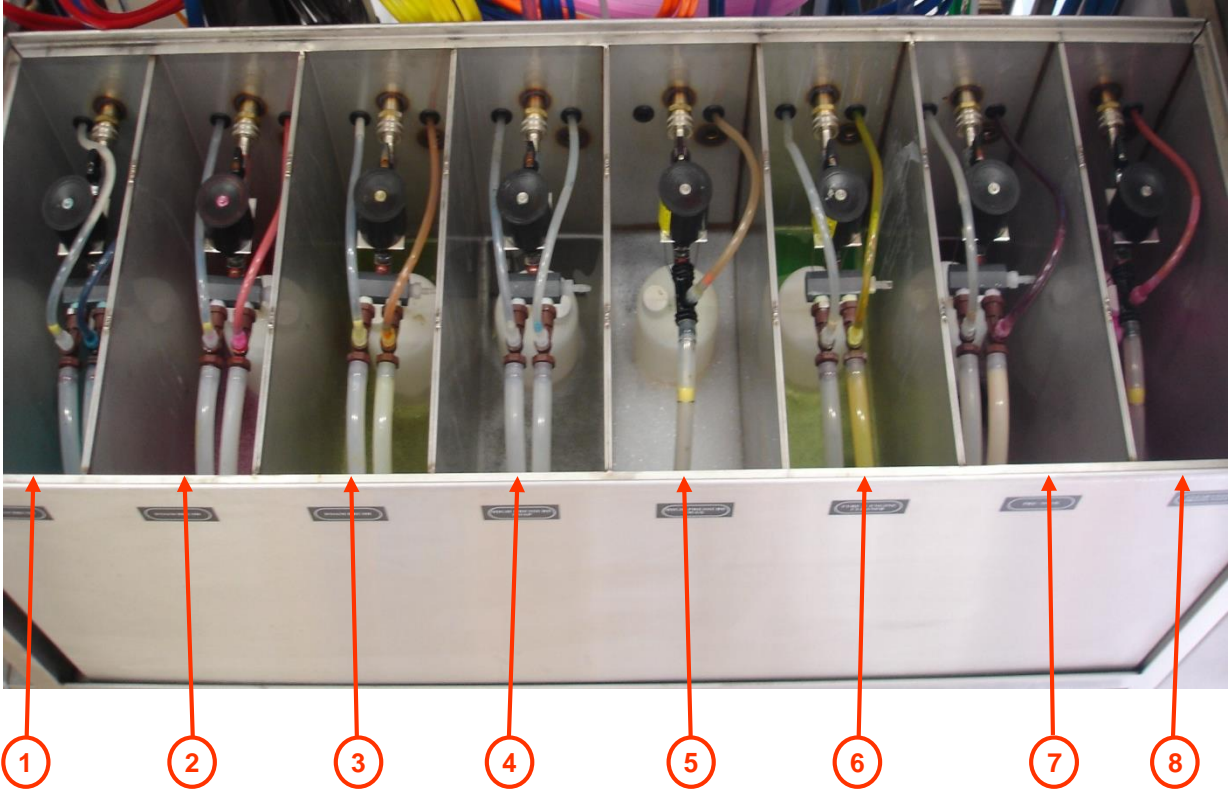

ITEM	PART#	DESCRIPTION
1		Foam Brush Tri Colour
2		Foam Brush Tri Colour
3		Foam Brush Tri Colour
4		High Pressure Soap
5		High Pressure Wax
6		Tyre / Engine Cleaner
7		Presoak
8		Clear Coat Protectant
9	DH24730	Strainer, 30 Mesh 1/2" Low Pressure Tank (Not Shown)
10	PDQ31019	Float Switch, 1/4" (Electric Pumps Only) (Not Shown)
11	GC0824	Solenoid, 1/2" 24V (GC) (Below Tank Only Tri Colour)
12	GC0824K	Solenoid Kit, 1/2" (GC) (Not Shown)

## Hydrominder 506 with SuperSat Attachment

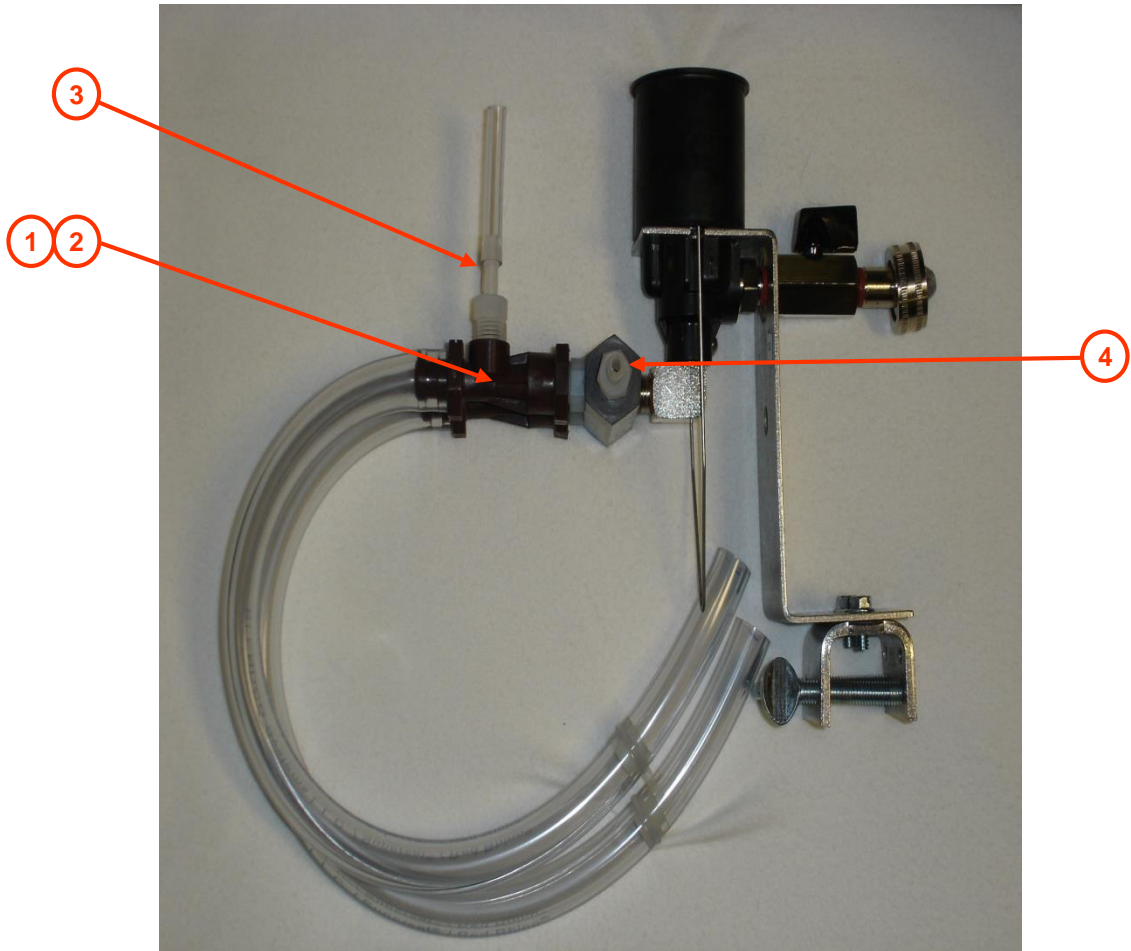

ITEM	PART#	DESCRIPTION
1	SSEDUCT2	Dual Educator, SuperSat
2	SSEDUCT1	Single Educator, SuperSat (Not Shown)
3	DH24706	Tip Kit - Push In, Hydrominder
4	SS7107	Valve Anti Siphon, SuperSat

### HydroMinder Model 506 Parts Diagram/List

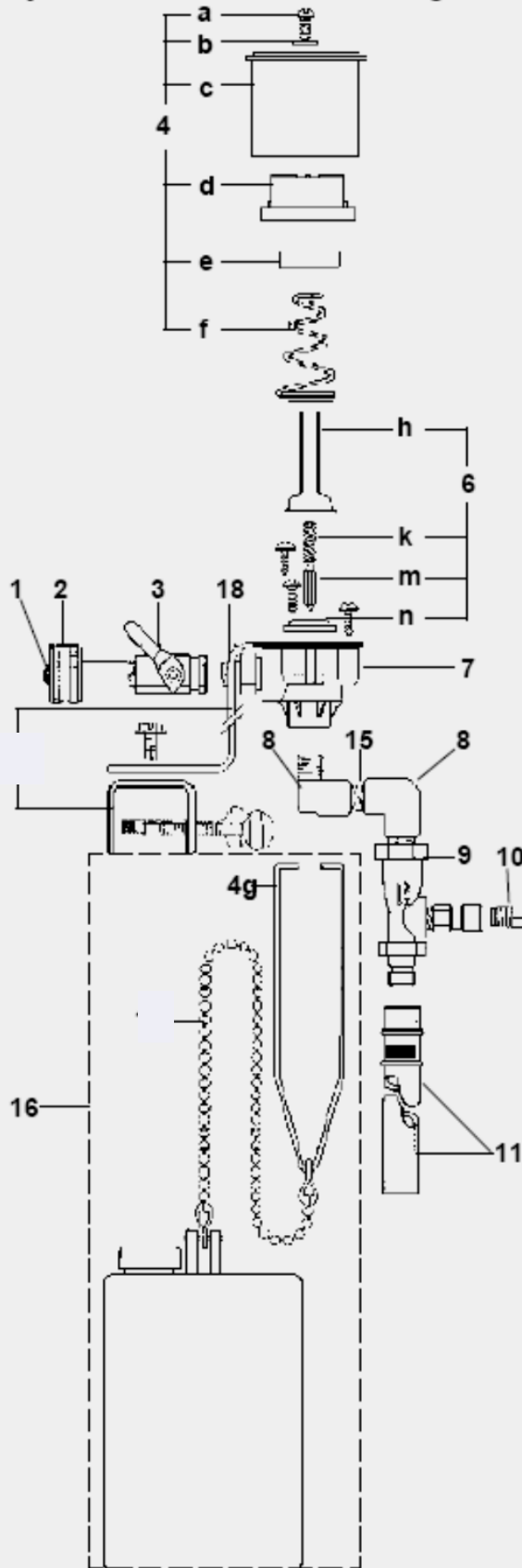

ITEM	PART#	DESCRIPTION
1	DH24719	Strainer Washer, 506 Hydrominder
2	IN506500	Swivel Nut, 506 Hydrominder
3	IN502000	Ball Valve, 506 Hydrominder
4	IN5051K	Magnet Kit, 506 Hydrominder
F	IN503200	Magnet Spring, 506 Hydrominder
6	DH24717	Valve Kit, 506 Hydrominder
7	DH24674	Valve Body, 506 Hydrominder
N	DH18484	Diaphragm, 506 Hydrominder
8	DH24545	Elbow, Brass 1/4" M/NPT x 1/4" F/NPT
9	DH24721	Eductor Kit, 506 Hydrominder
10	DH24715	Tip Kit – Threaded, 506 Hydrominder
11	DH17688	Discharge Tube Assembly, Brass
12	IN50589A	Pickup Hose with Foot Valve
13	DH24716	Foot Valve, Blue
13	DH24677	Foot Valve, Grey
15	IN519000	Nipple 1/4" Short, 506 Hydrominder
16	DH24718	Float & Chain, 506 Hydrominder
18	DH24121	Nipple Reducing Hex, 3/8" x 1/4"

# Low Pressure Solenoids

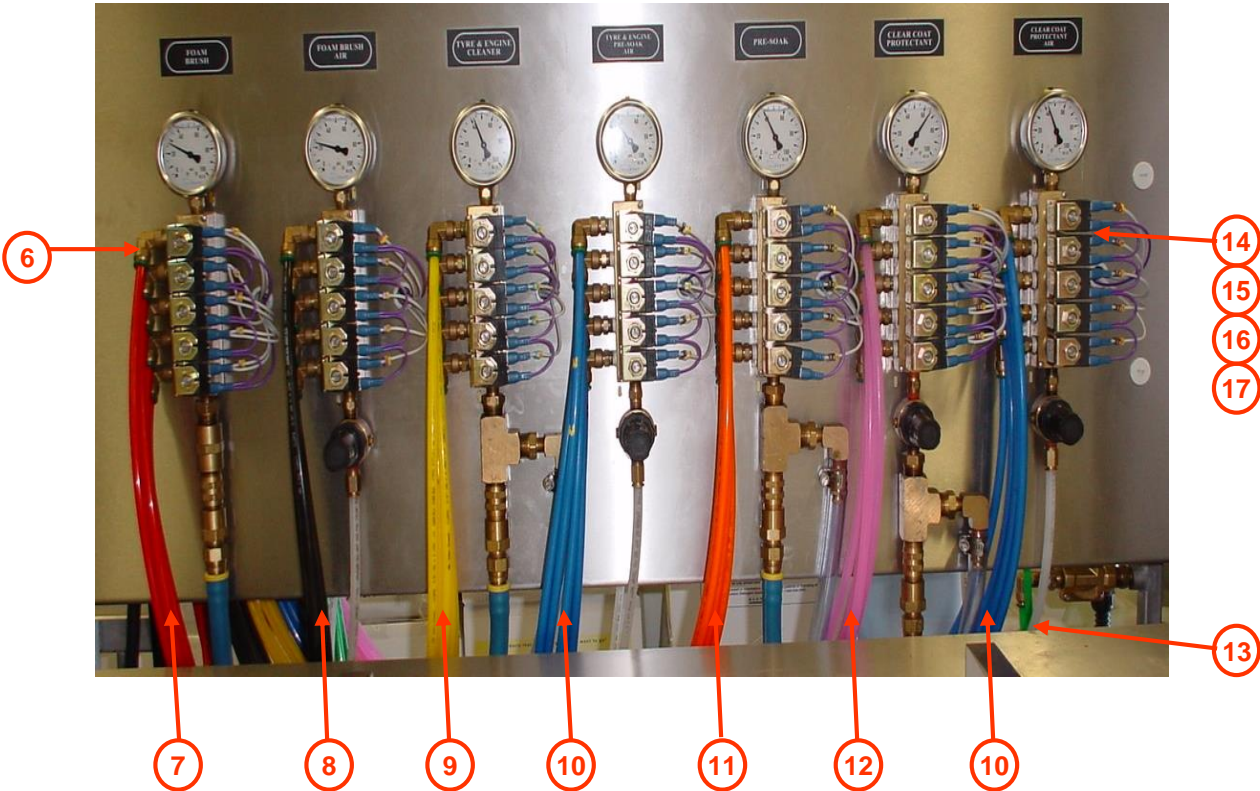
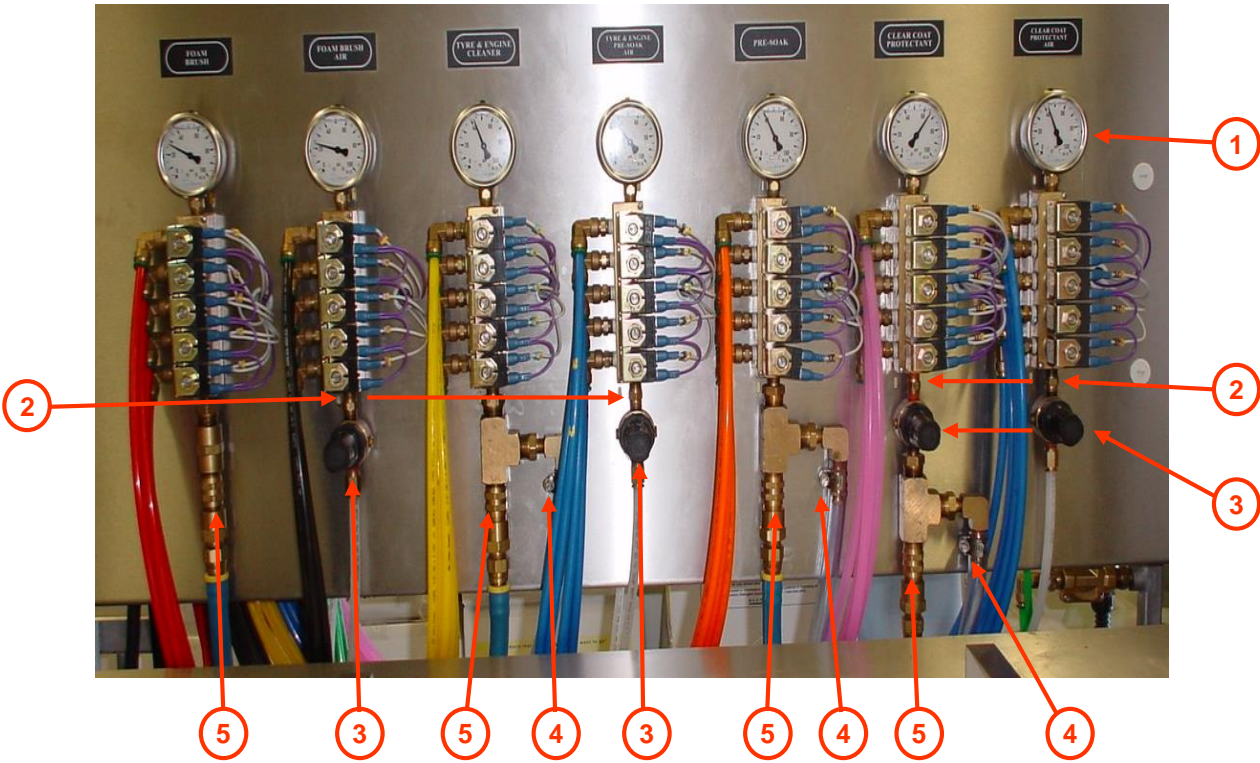

## Low Pressure Solenoids - Parts List

ITEM	PART#	DESCRIPTION
1	DH24664	Gauge, 0-100psi
2	DH24896	Check Valve, 1/4" MxM Brass with S/Steel Circlip
3	DH25093	Pressure Regulator, Air & Water
4	DH25079	Pop Off Valve
5	DH24895	Check Valve, 1/2" MxM Brass with S/Steel Circlip
6	DH14500	Elbow Swivel, 3/8" Tube x 1/4" NPT
7	DH22156	Hose, Poly Tubing 3/8" Red
8	DH22152	Hose, Poly Tubing 3/8" Black
9	DH22150	Hose, Poly Tubing 3/8" Yellow
10	DH22153	Hose, Poly Tubing 3/8" Blue
11	DH22155	Hose, Poly Tubing 3/8" Orange
12	DH22151	Hose, Poly Tubing 3/8" Natural
13	DH22154	Hose, Poly Tubing 3/8" Green
14	DH18437	Solenoid, 5 Station Complete (Kip)
15	DH18436	Solenoid, 4 Station Complete (Kip) (Not Shown)
16	DH18435	Solenoid, 3 Station Complete (Kip) (Not Shown)
17	DH18434	Solenoid, 2 Station Complete (Kip) (Not Shown)

# Water Inlet Solenoids with Reclaim Option

**As Shown on Pump Stand**

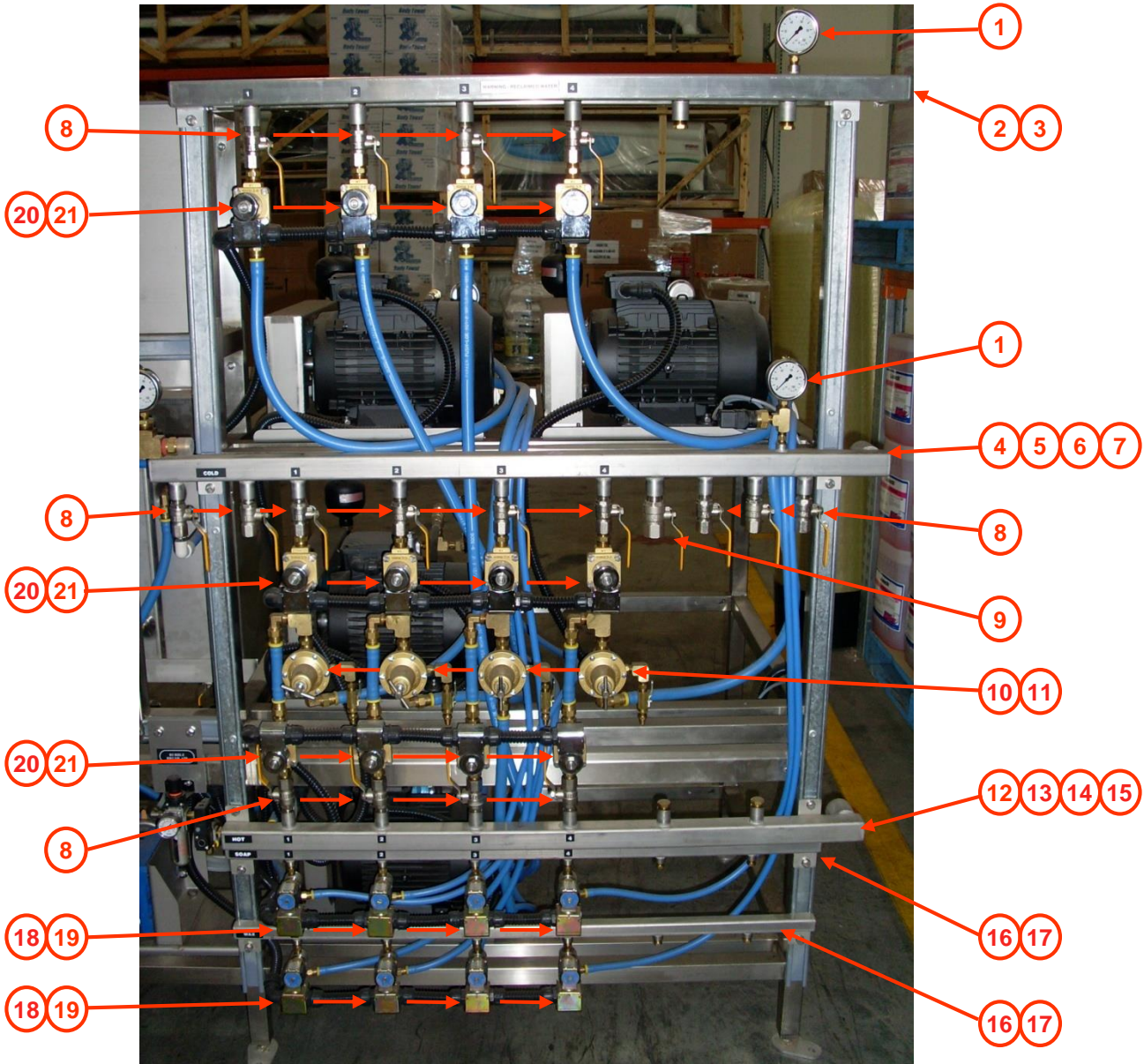



## Water Inlet Solenoids with Reclaim Option – Parts List

ITEM	PART#	DESCRIPTION
1	DH24664	Gauge, 0-100psi
2	<i>Optional</i>	<i>Manifold, Reclaim 3 Bay S/Steel (Not Shown)</i>
3	<i>Optional</i>	<i>Manifold, Reclaim 6 Bay S/Steel</i>
4	PW20048	Manifold, Cold Water 3 Bay (Old) S/Steel (Not Shown)
5	PW20054	Manifold, Cold Water 3 Bay (New) S/Steel (Not Shown)
6	PW20045	Manifold, Cold Water 6 Bay (Old) S/Steel (Not Shown)
7	PW20056	Manifold, Cold Water 6 Bay (New) S/Steel
8	PW10162	Ball Valve, MxF 1/2"
9	PW10163	Ball Valve, MxF 3/4"
10	DH25201	Pressure Regulator, Generant
11	DH25202	Pressure Regulator Kit, Generant (Not Shown)
12	PW20046	Manifold, Hot Water 3 Bay (Old) S/Steel (Not Shown)
13	PW20055	Manifold, Hot Water 3 Bay (New) S/Steel (Not Shown)
14	PW20044	Manifold, Hot Water 6 Bay (Old) S/Steel (Not Shown)
15	PW20057	Manifold, Hot Water 6 Bay (New) S/Steel
16	PW20053	Manifold, Hot Soap / Wax 6 Bay
17	PW20058	Manifold, Hot Soap / Wax 3 Bay (Not Shown)
18	DH18496	Solenoid, 424P-2 24V S/Steel Viton (Dema)
19	MK44105K	Solenoid Kit , 401P 1/4" (Dema) (Not Shown)
20	GC0824	Solenoid, 1/2" 24V (GC)
21	GC0824K	Solenoid Kit, 1/2" (GC) (Not Shown)

# Electrical Control Cabinet External

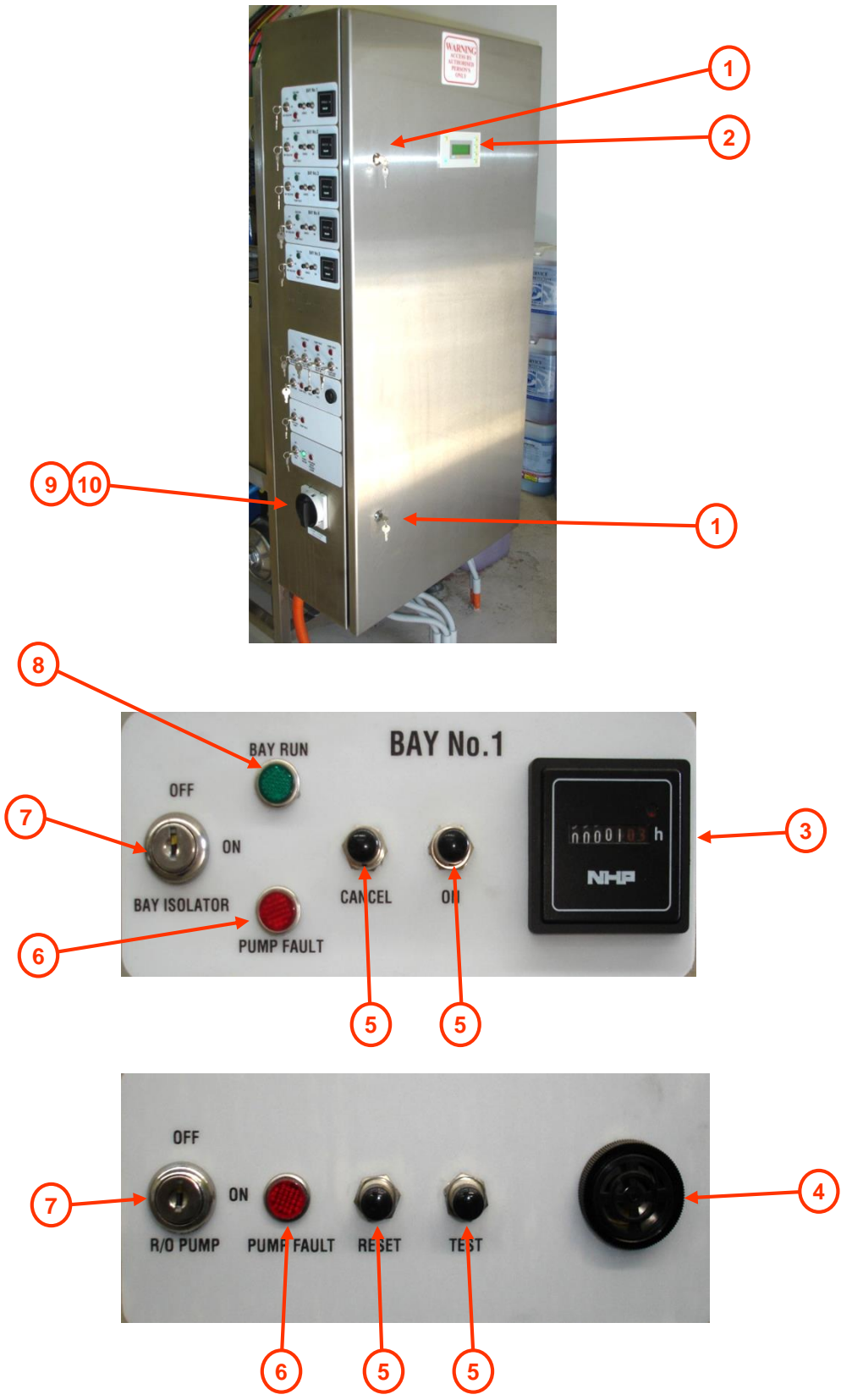

## Electrical Control Cabinet External – Parts List

ITEM	PART#	DESCRIPTION
1	PW10443	Lock, Key & Tab S/Steel Electrical Cabinet
2	PW10077	Operator Panel LCD (For Bonus time) (Optional)
3	PWRQ48024V	Hour Run Meter
4	DH19380	Touch Select Beeper
5	DH18674	Switch, Push Button
6	DH73612	Lamp, Red Indicator 24V
7	PW10001	Switch Key
8	DH73610	Lamp, Green Indicator 24V
9	PWLFS2-N-8-175	Handle, Type N for 40 Amp Load Break
10	PWLE-63-1753	Load Break Switch 3 Phase Panel Mount 63 Amp

# Electrical Control Cabinet Internal

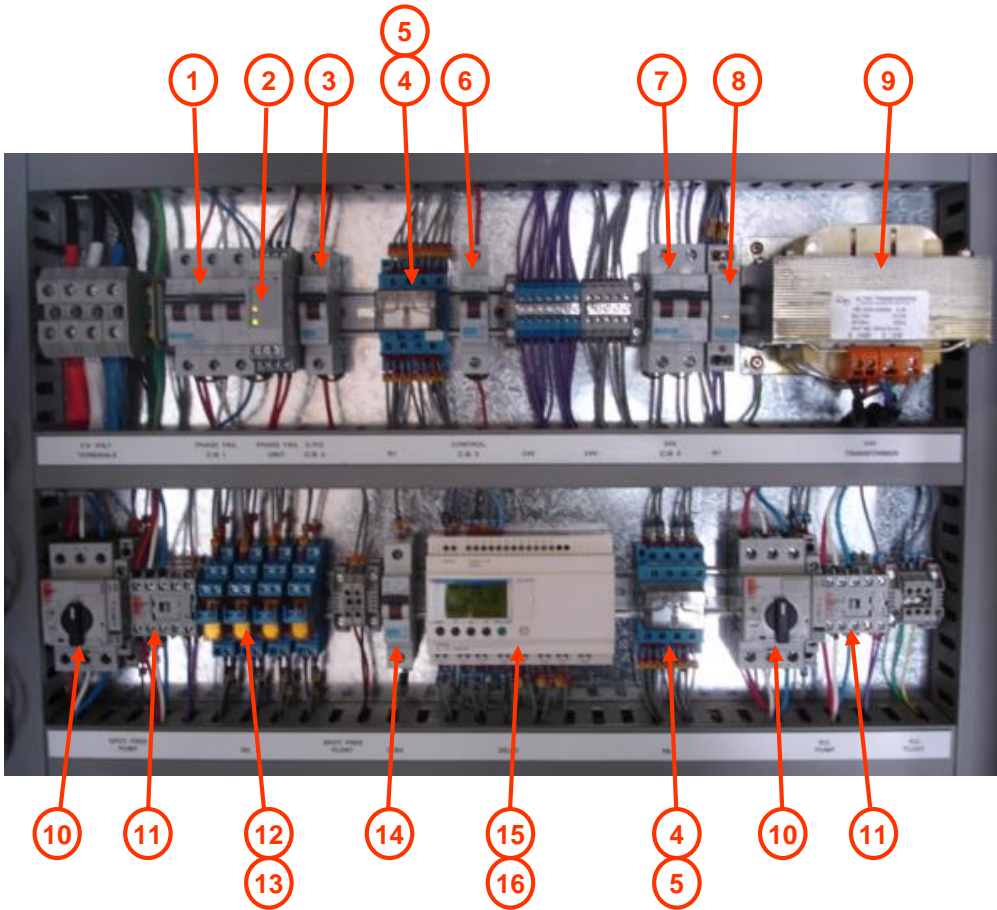

## Optional Bonus Time Section

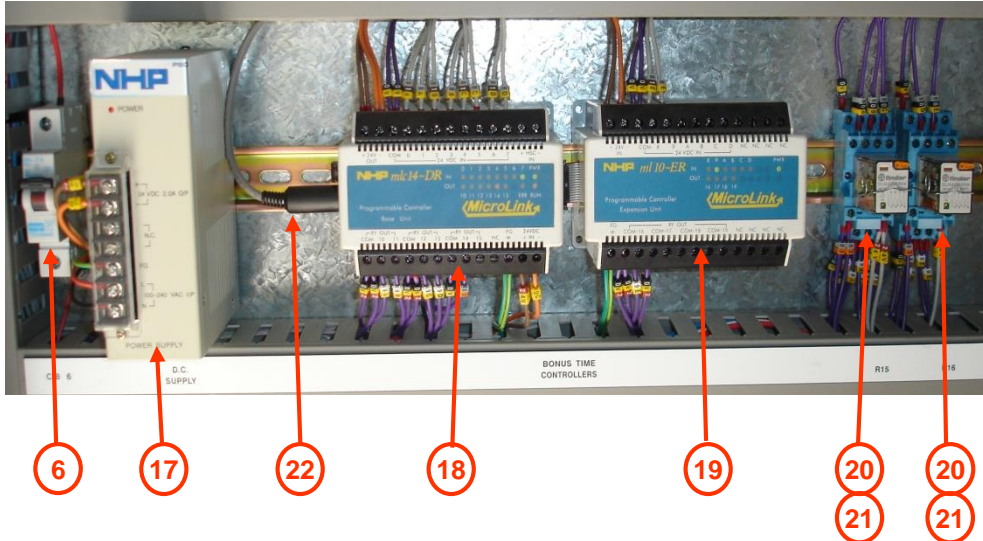

## Electrical Control Cabinet Internal – Parts List

ITEM	PART#	DESCRIPTION
1	PWDINT6304C	Circuit Breaker, 6kA 3 Pole 4 Amp
2	PWDPA01DM48	Monitoring Relay, Phase Failure Unit
3	PWDINT6116C	Circuit Breaker, 6kA Single Pole 16 Amp
4	PW96.74	Relay Base, DIN Rail Socket 4 Pole
5	PW56.3424VAC	Relay, Mini Plug-In 12 Amp 4 Pole
6	PWDINT6104C	Circuit Breaker, 6kA Single Pole 4 Amp
7	PWDINT6220C	Circuit Breaker, 6kA 2 Pole 20 Amp
8	PW10133	Vacuum Contactor 2 Pole
9	PW10021	Transformer 240V - 24V 500VA
10	PWKTA7-25S-6.3A	Circuit Breaker, 6.3 Amp
11	PW10004	Contactor, CA4-12-10 24VAC
12	PW10008	Relay Base, 2 Pole
13	PW40.5224VAC	PCB Relay, 2 Pole
14	PWDINT6102C	Circuit Breaker, 6kA Single Pole 2 Amp
15	PW10201	Zelio, 20 IO 1800gpd R/O
16	PW10202	Zelio, 20 IO 3600gpd R/O
17	PW10009	Microlink, Power Supply
18	PW10075	Microlink PLC
19	PW10076	Microlink PLC, Expansion Unit
20	PW10084	Relay Base
21	PW10083	Relay, 4 Pole 24VAC 7 Amp
22	PW10078	Microlink, Cable 25 Pin

# Electrical Control Cabinet Internal

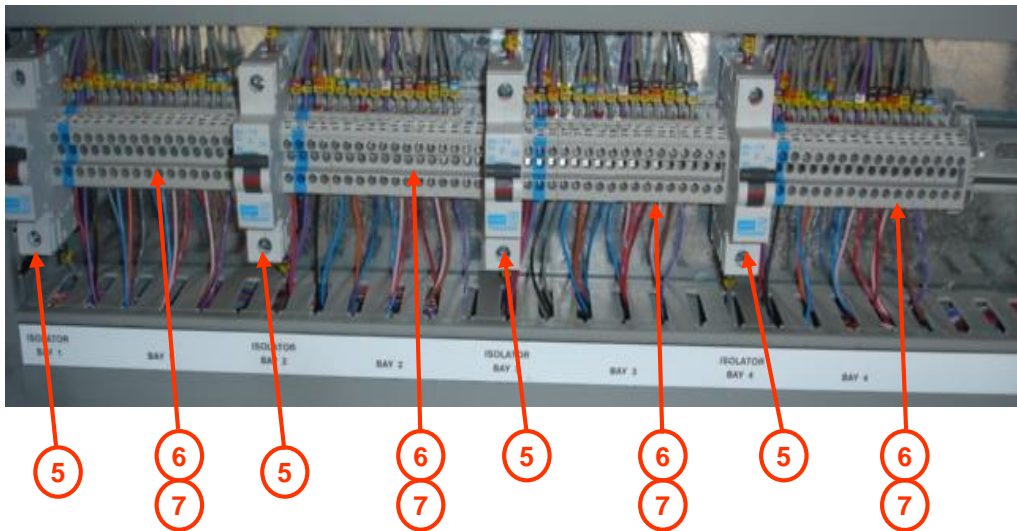
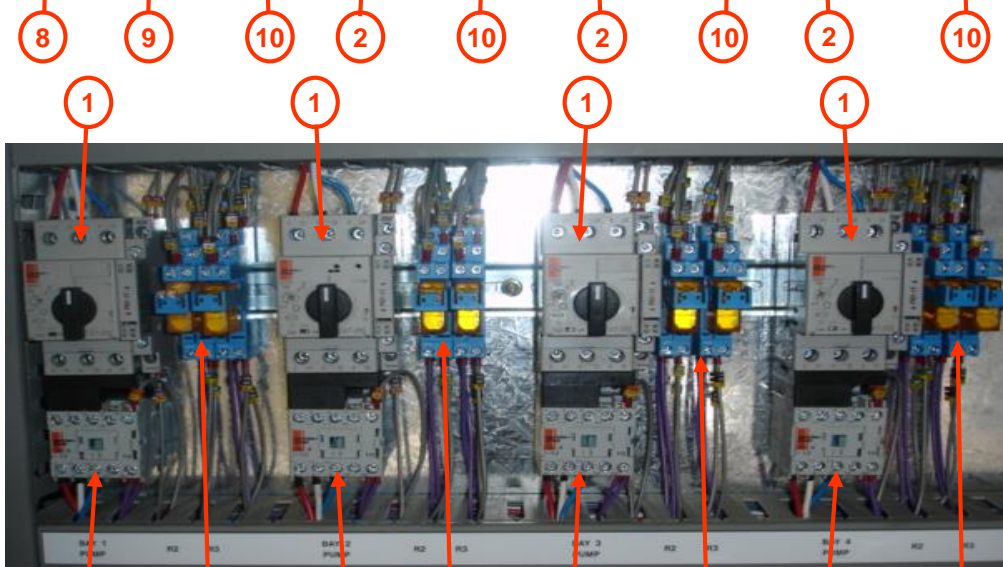
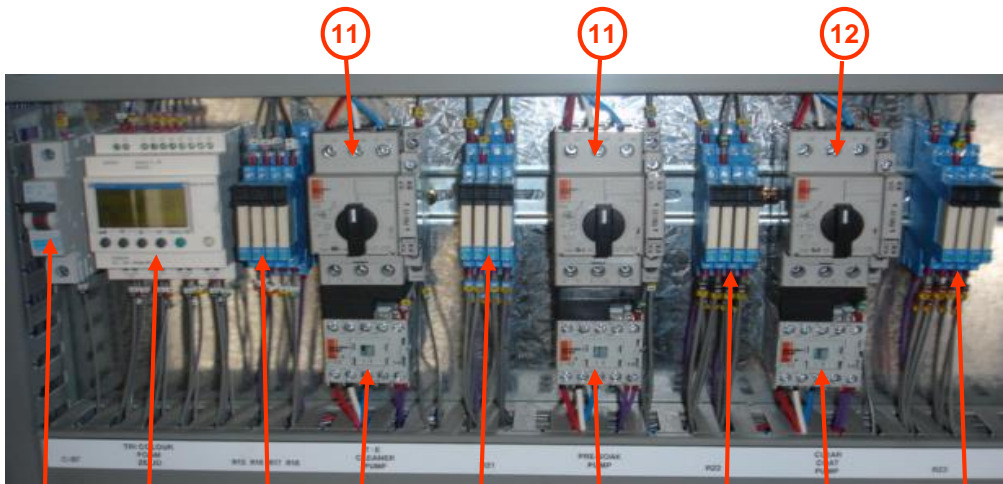

## Electrical Control Cabinet Internal – Parts List

ITEM	PART#	DESCRIPTION
1	PWKTA7-25S-10A	Circuit Breaker, 10 Amp
2	PW10004	Contactor, CA4-12-10 24VAC
3	PW10008	Relay Base, 2 Pole
4	PW40.5224VAC	PCB Relay, 2 Pole
5	PWDINT6106C	Circuit Breaker, 6kA Single Pole 6 Amp
6	PW10079	Terminal, 4mm Grey
7	PWV7-WD4	Terminal Block, 2 Levels Through 4mm DIN Mount (Not Shown)
8	PWDINT6102C	Circuit Breaker, 6kA Single Pole 2 Amp
9	PW10206	Zelio, Triple Foam Brush (6 Bay)
10	PW38.5124VACDC	Relay, Interface Module DIN MT 24V AC/DC
11	PWKTA7-25S-2.5A	Circuit Breaker, 2.5 Amp
12	PWKTA7-25S-4A	Circuit Breaker, 4 Amp





## **SECTION 3**

# **Water Treatment**

### Water Softener

- Twin Tank Water Softener
- Water Softener Control Valve
- Carbon Filter Control Valve

### Reverse Osmosis (RO) – Spot Free Water

- 1800 GPD Wall / Floor Mount
- 1800 GPD Pump Stand Mount
- 3600 GPD Wall / Floor Mount
- 3600 GPD Pump Stand Mount
- 5400 GPD Wall / Floor Mount





# Twin Tank Water Softener



ITEM	DESCRIPTION
1	Fleck Control Valve
2	Brine Tank
3	Resin Tanks

## Complete Water Softener Systems with Part Numbers

Model Number	DH66204	Part Number	DH66206	Part Number
		M2060		M2069
Head	9000	DHK4026E-22050	9000	DHK4026E-22050
Flow Restrictor	7GPM	DHTPFCTH075V	7GPM	DHTPFCTH075V
2 x Resin Tank	12" x 52"	-----	16" x 65"	PW10446
1 x Brine Tank	18" x 40"	DH66276	24" x 41"	DH66275
Resin	4 cuft	DHA4000	8 cuft	DHA4000
Gravel	60 lbs	DHA7005A	160 lbs	DHA7005A

Model Number	DH66212	Part Number	DH66213	Part Number
		M2222		M2224
Head	9500	DHK4029XE-22050	9500	DHK4029XE-22050
Flow Restrictor	7GPM	DHTPFCTH075V	12GPM	DHTPECTH10V
2 x Resin Tank	16" x 65"	PW10446	21" x 62"	PW10445
1 x Brine Tank	24" x 41"	DH66275	24" x 50"	-----
Resin	8 cuft	DHA4000	10 cuft	DHA4000
Gravel	160 lbs	DHA7005A	200 lbs	DHA7005A

Model Number	DH66215	Part Number	DH66216	Part Number
		M2228		M2230
Head	9500	DHK4029XE-22050	9500	DHK4029XE-22050
Flow Restrictor	12GPM	DHTPECTH10V	12GPM	DHTPFCTH075V
2 x Resin Tank	21" x 62"	PW10445	24" x 72"	-----
1 x Brine Tank	24" x 50"	-----	30" x 48"	-----
Resin	14 cuft	DHA4000	16 cuft	DHA4000
Gravel	200 lbs	DHA7005A	400 lbs	DHA7005A

## Complete Carbon Filter Systems with Part Numbers

Model Number	DH66342	Part Number	DH66347	Part Number
		N2052		N2058
<b>Head</b>	2510	DHK4022	2750	DHK4010CF
<b>Flow Restrictor</b>	4 GPM	-----	7 GPM	DHK4512408
<b>Tank</b>	12" x 52"	-----	16" x 65"	PW10446
<b>Carbon (total)</b>	2 cuft	DHA9031A	4 cuft	DHA9031A
<b>Gravel (total)</b>	30 lbs	DHA7005A	80 lbs	DHA7005A

# Water Softener Control Valve

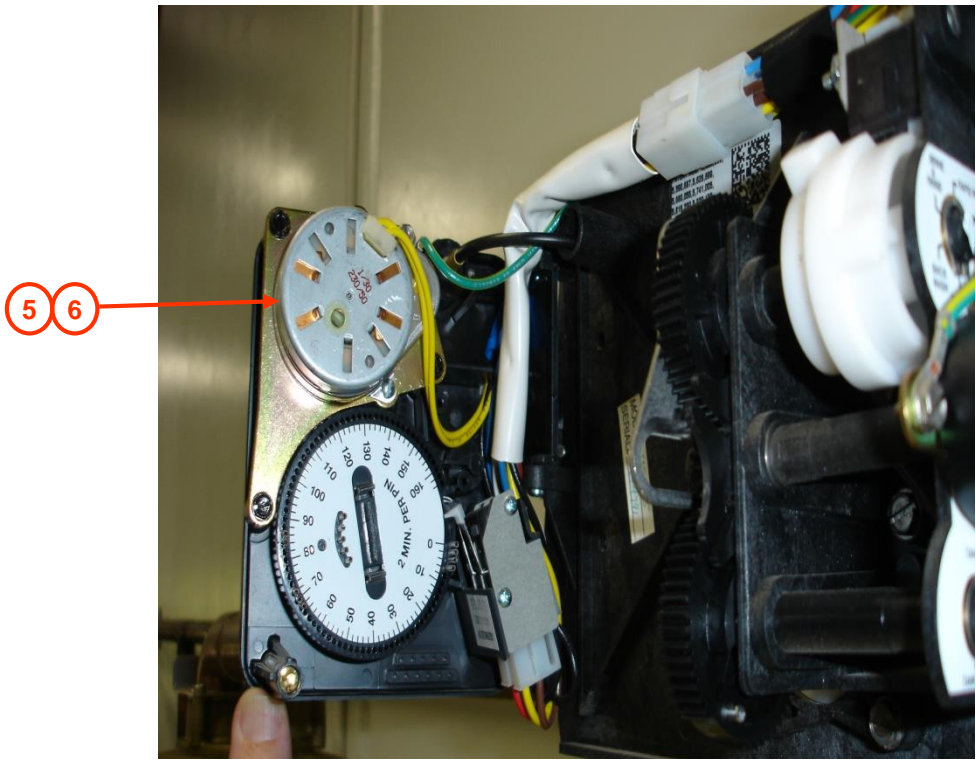
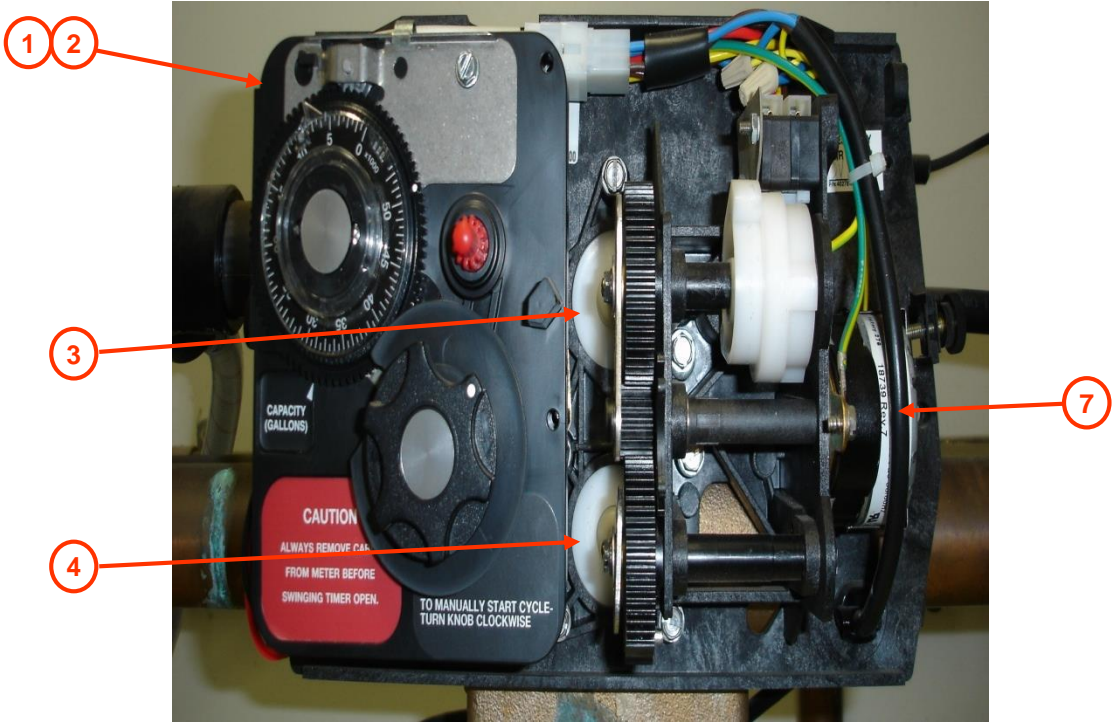

## Water Softener Control Valve – Parts List

ITEM	PART#	DESCRIPTION
1	DHK4026E-22050	Water Softener Head Model 9000
2	DHK4029XE-22050	Water Softener Head Model 9500
3	DHK4518739	Drive Motor, 220V 90,91,95 Valve 1rpm
4	see below	Upper Piston & Seal Assembly
5	see below	Lower Piston & Seal Assembly
6	DHK4515442	Drive Motor, 240V 1/15
7	DHK4518824	Timer Motor, 220V 90,91,95 Valve 1/30rpm

## Piston Assembly & Seal Kits – Spare Parts List

PART#	DESCRIPTION
DHK4560108	Upper Piston Assembly, 9500 Valve
DHK4560109	Lower Piston Assembly, 9500 Valve
DHK4560125	Upper Seal Kit, 9000 Valve
DHK4560133	Lower Seal Kit, 9500 Valve
DHK4560134	Upper Seal Kit, 9500 Valve
DHK4560232-110	Cover, Fleck Head
DHK4560350	Brine Valve Assembly, 9000 Valve
DHK4560385	Injector / Drain Module Assembly. 9000 Valve
DHK4560400	Upper Piston Assembly, 9000 Valve
DHK4560401	Lower Piston Kit, 9000 Valve
DHK4560421	Lower Seal Kit, 9000 Valve

# Carbon Filter Control Valve

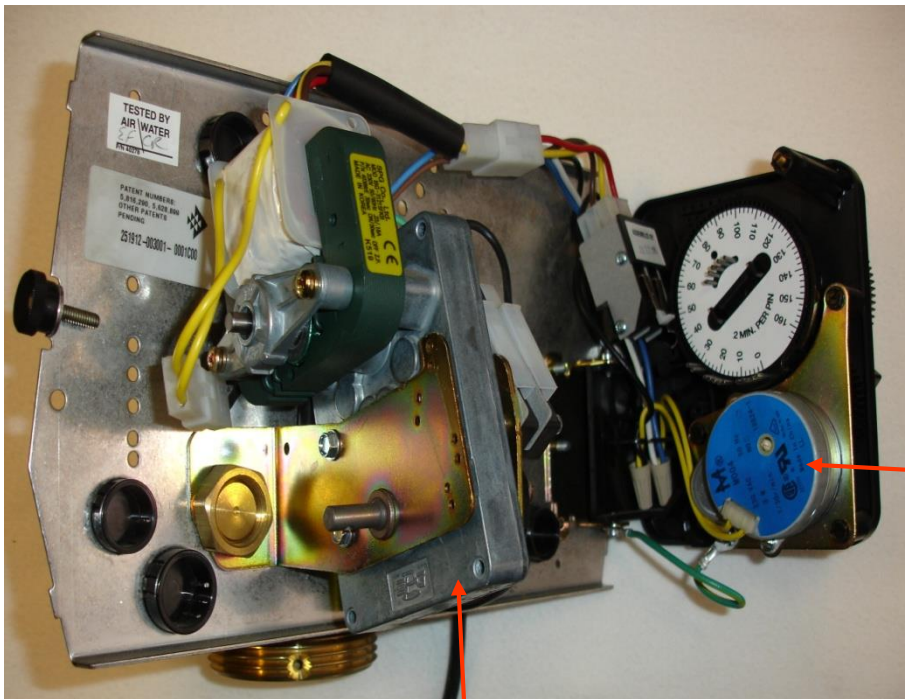
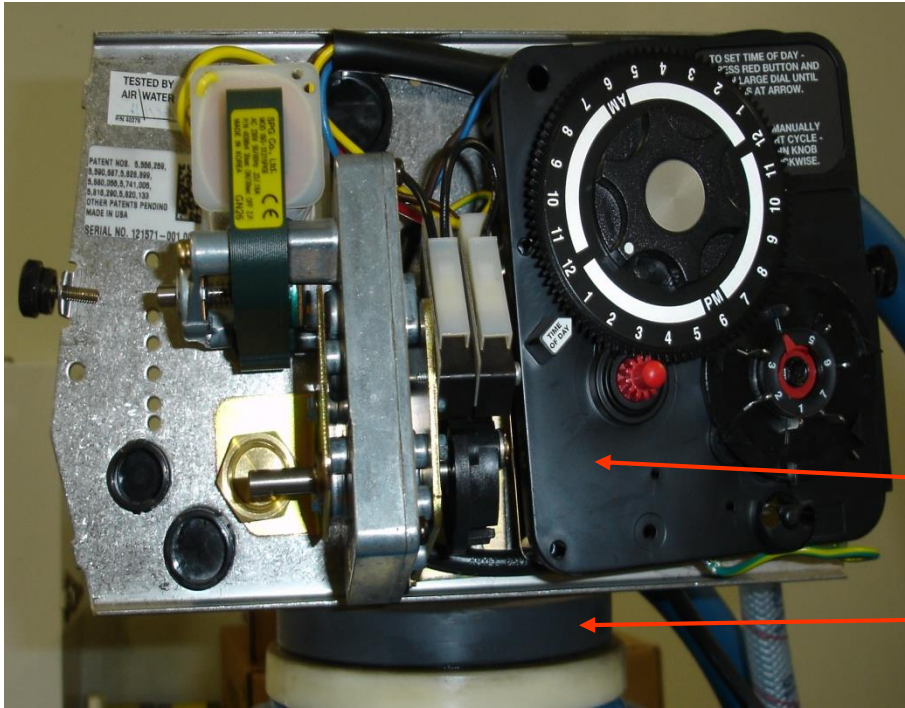



## Carbon Filter Control Valve - Parts List

ITEM	PART#	DESCRIPTION
1	DHK4022	Carbon Filter Head, 2510
2	DHK4010CF	Carbon Filter Head, 2750
3	DH61662	Bushing, Mineral Tank 4 x 2.5 PVC
4	DHK4515442	Drive Motor, 240V 1/15
5	DHK4518824	Timer Motor, 220V 90,91,95 Valve 1/30rpm
6	DHK4515305	Drive Motor, 240V, 2500 Valve

## Carbon Filter Control Valve – Spare Parts List

PART#	DESCRIPTION
DHK4519228	Adaptor Coupling, 2510
DHK4022	Carbon Filter Head, 2510
DHK4518825	Drive Motor, 220V 50hz 1/15rpm
DHK4560232-110	Cover, Fleck Head
DHK4022FTCB075	Valve Filter.75, 2510
DHK4514038	Meter Cap Assembly, 5600 / 2510
DHK4010CF	Carbon Filter Head, 2750
DHK4560090-HF	Piston Assembly, 2750 / 2900
DHK4560090	Piston Assembly, 2500 Valve
DHK4560090-HF	Piston Assembly, 2750/2900 Valve
DHK4560102	Piston Assembly, 5600 Valve
DHK4560103	Piston Assembly, 2900 Valve
DHK4560121	Seal Kit, 2500 Valve
DHK4560128	Lower Seal Kit, 2900 Valve

## Complete Water Softener Systems – Single Tank SXT Controller

**Softener 3/4" 2510 Fleck Valve Single Tank 2 cu ft - Part # DH66202**

	SPECIFICATIONS	REORDER PART #
Valve	2510	DHK4022
Pipe Size	3/4"	
Flow Rate Cont./Peak	19/24 GPM	
Flow Restrictor	4 GPM	DHTPFCTH04V
Resin Tank	12" x 52"	DH66401
Brine Tank	18" x 40"	DH66276
Resin (cu. Ft.)	2	DHA4000A
Gravel (lbs)	30	DHA7005B

**Softener 1" 2750 Fleck Valve Single Tank 4 cu ft - Part # DH66207**

	SPECIFICATIONS	REORDER PART #
Valve	2750	DHK4010CF
Pipe Size	1"	
Flow Rate Cont./Peak	26/33 GPM	
Flow Restrictor	7 GPM	DHTPFCTH075V
Resin Tank	16" x 65"	DH66341
Brine Tank	18" x 40"	DH66276
Resin (cu. Ft.)	4	DHA4000A
Gravel (lbs)	80	DHA7005B

**Softener 1.5" 2850 Fleck Valve Single Tank 5 cu ft - Part # DH66214**

	SPECIFICATIONS	REORDER PART #
Valve	2850	DHK4050-SXT-22050
Pipe Size	1.5"	
Flow Rate Cont./Peak	46/60 GPM	
Flow Restrictor	12 GPM	DHTPECTH10V
Resin Tank	18" x 65"	DH66342
Brine Tank	24" x 41"	DH66275
Resin (cu. Ft.)	5	DHA4000A
Gravel (lbs)	100	DHA7005B

**Softener 1.5" 2850 Fleck Valve Single Tank 7 cu ft - Part # DH66217**

	SPECIFICATIONS	REORDER PART #
Valve	2850	DHK4050-SXT-22050
Pipe Size	1.5"	
Flow Rate Cont./Peak	46/60 GPM	
Flow Restrictor	12 GPM	DHTPECTH10V
Resin Tank	21" x 62"	DH66402
Brine Tank	24" x 50"	DH66277
Resin (cu. Ft.)	7	DHA4000A
Gravel (lbs)	100	DHA7005B

## Complete Carbon Filter Systems – Single Tank SXT Controller

### Carbon Filter 2510 SXT 2 cu ft - Part # DH66338

	SPECIFICATIONS	REORDER PART #
Valve	2510	DHK4022
Pipe Size	3/4"	
Flow Rate Cont./Peak	19/24 GPM	
Carbon Tank	12" x 52"	DH66401
Carbon (cu. Ft.)	2	DHA4000A
Gravel (lbs)	30	DHA7005B

### Carbon Filter 2750 SXT 4 cu ft - Part # DH66343

	SPECIFICATIONS	REORDER PART #
Valve	2750	DHK4010CF
Pipe Size	1"	
Flow Rate Cont./Peak	26/33 GPM	
Carbon Tank	16" x 65"	DH66341
Carbon (cu. Ft.)	4	DHA4000A
Gravel (lbs)	80	DHA7005B

# 1800 GPD RO Wall / Floor Mount

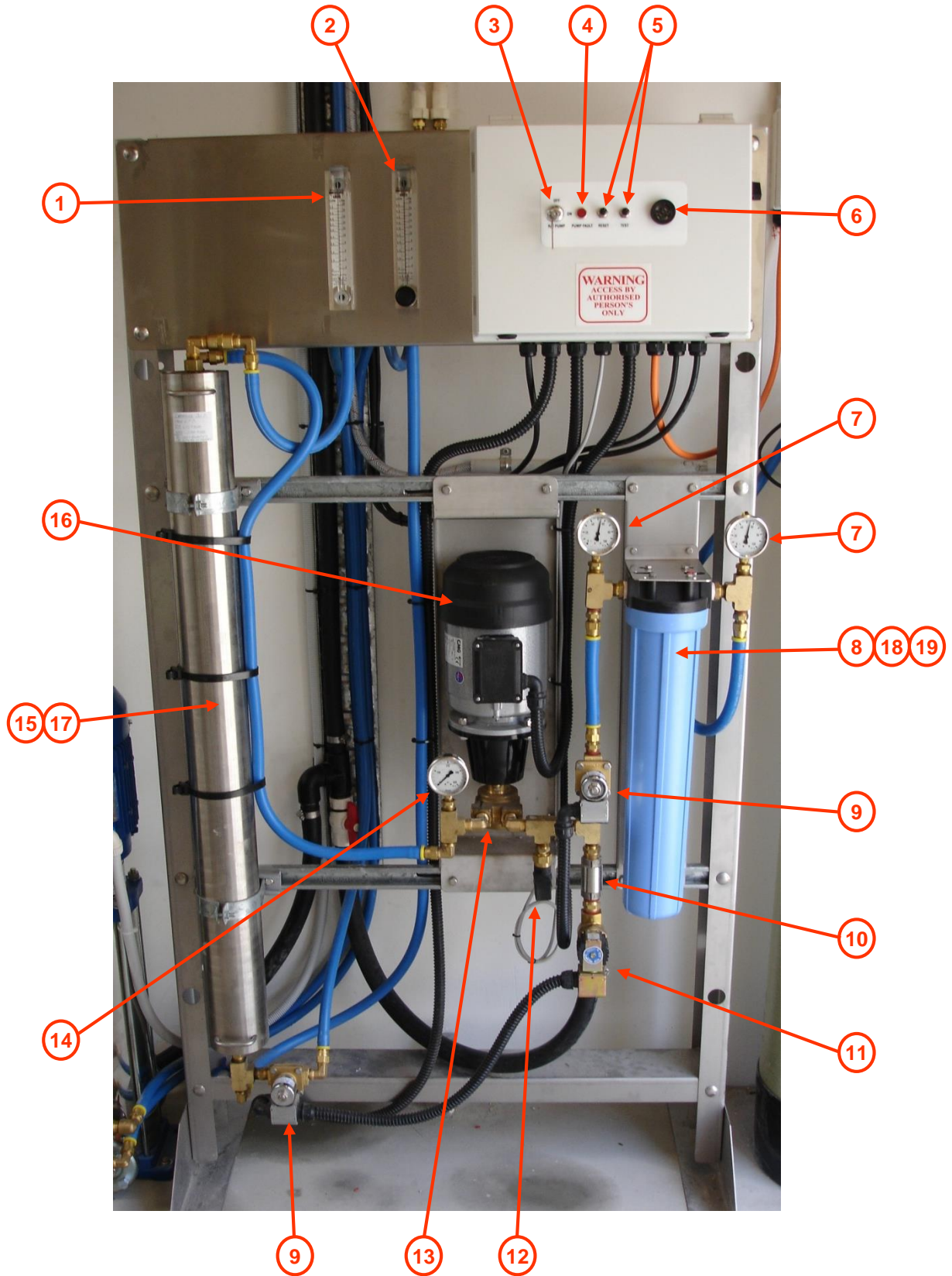

## 1800 GPD RO Wall / Floor Mount - Parts List

ITEM	PART#	DESCRIPTION
1	DH18162	Flow Meter, 0.5-5.0gpm
2	DH18165	Flow Meter, 0.5-5.0gpm C/W Waste Control
3	PW10001	Switch Key
4	DH73612	Lamp, Red Indicator 24V
5	DH18674	Switch, Push Button
6	DH19380	Touch Select Beeper
7	DH24664	Gauge, 0-100psi
8	DH62561	Filter Housing 20" (Amatek)
9	GC0824	Solenoid, 1/2" 24V (GC)
10	DH24912	Check Valve, 3/4" FxF S/Steel Low Pressure
11	DH18499	Solenoid, 416P 3/4" 24V (Dema)
12	PW10022	Pressure Switch, PDA, R/O & Main Water
13	PDQ62156	Pump, Procon 2508AF
14	DH24702	Gauge, 0-400psi
15	DH63519	Membrane Housing, S/Steel 4040
16	PW10041	Motor, 3 Phase for R/O (CMG)
17	DH63512	Membrane, TW30-4040 18 (Filmtec) (Not Shown)
18	DH62526	Filter, 20" 1 Micron (Not Shown)
19	DH62527	Filter, 20" 5 Micron (Not Shown)



# Electrical Cabinet for RO Wall / Floor Mount

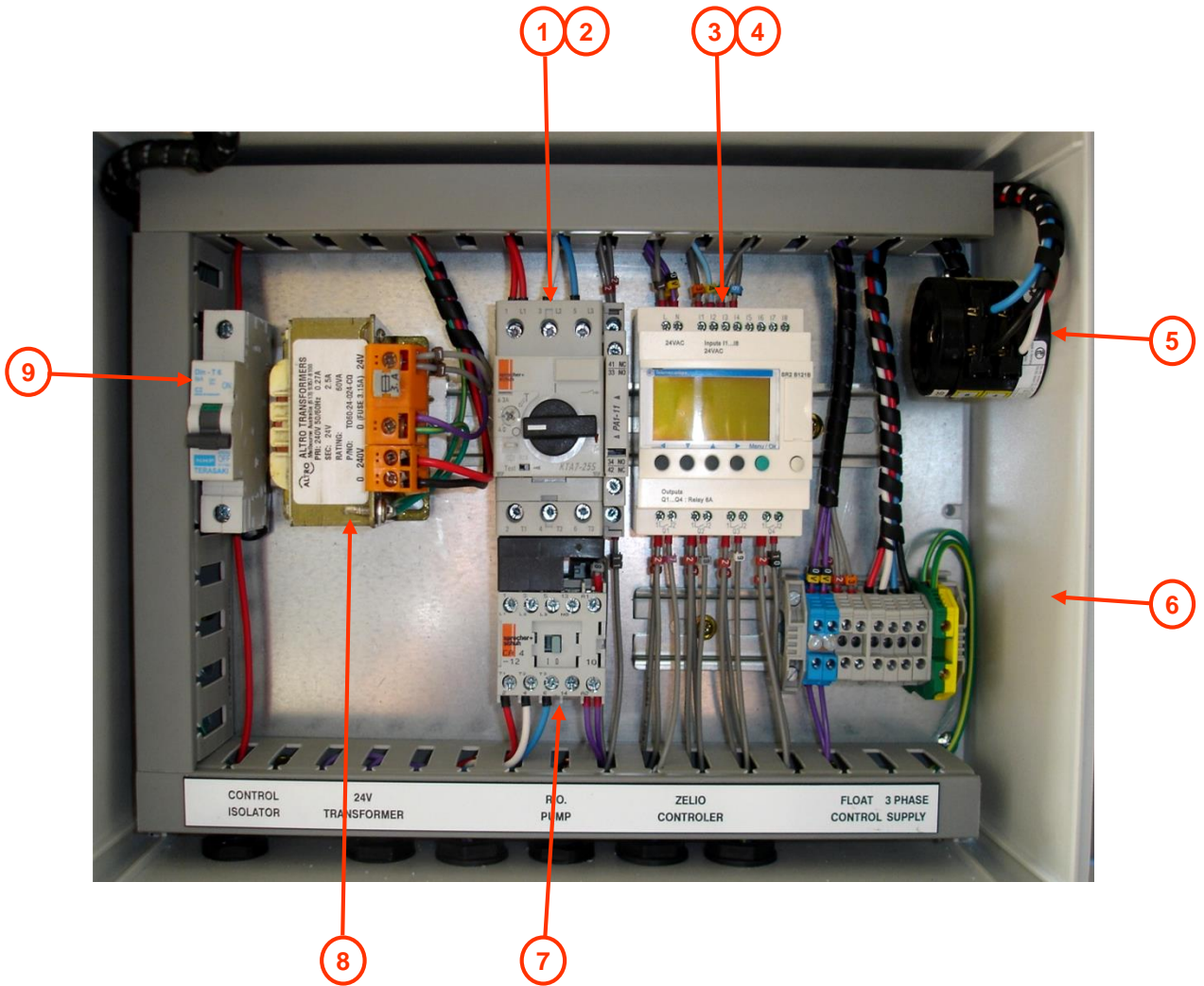

ITEM	PART#	DESCRIPTION
1	PWKTA7-25S-6.3A	Circuit Breaker, 6.3 Amp
2	PWKTA7-25S-2.5A	Circuit Breaker, 2.5 Amp
3	PW10207	Zelio, 10 IO 1800 GPD R/O Wall Mount
4	PW10208	Zelio, 10 IO 3600 GPD R/O Wall Mount
5	PWB2NA420P	Cam Switch Isolator, Off/On 3 or 4 Pole
6	PWCABPC403018G3B	Enclosure, Polycarbonate 400mm x 300mm x 180mm
7	PW10004	Contactor, CA4-12-10 24VAC
8	PW10020	Transformer, 240V - 24V 60VA S/Fuse D/Rail
9	PWDINT6106C	Circuit Breaker, 6kA Single Pole 6 Amp

# 1800 GPD RO Pump Stand Mount

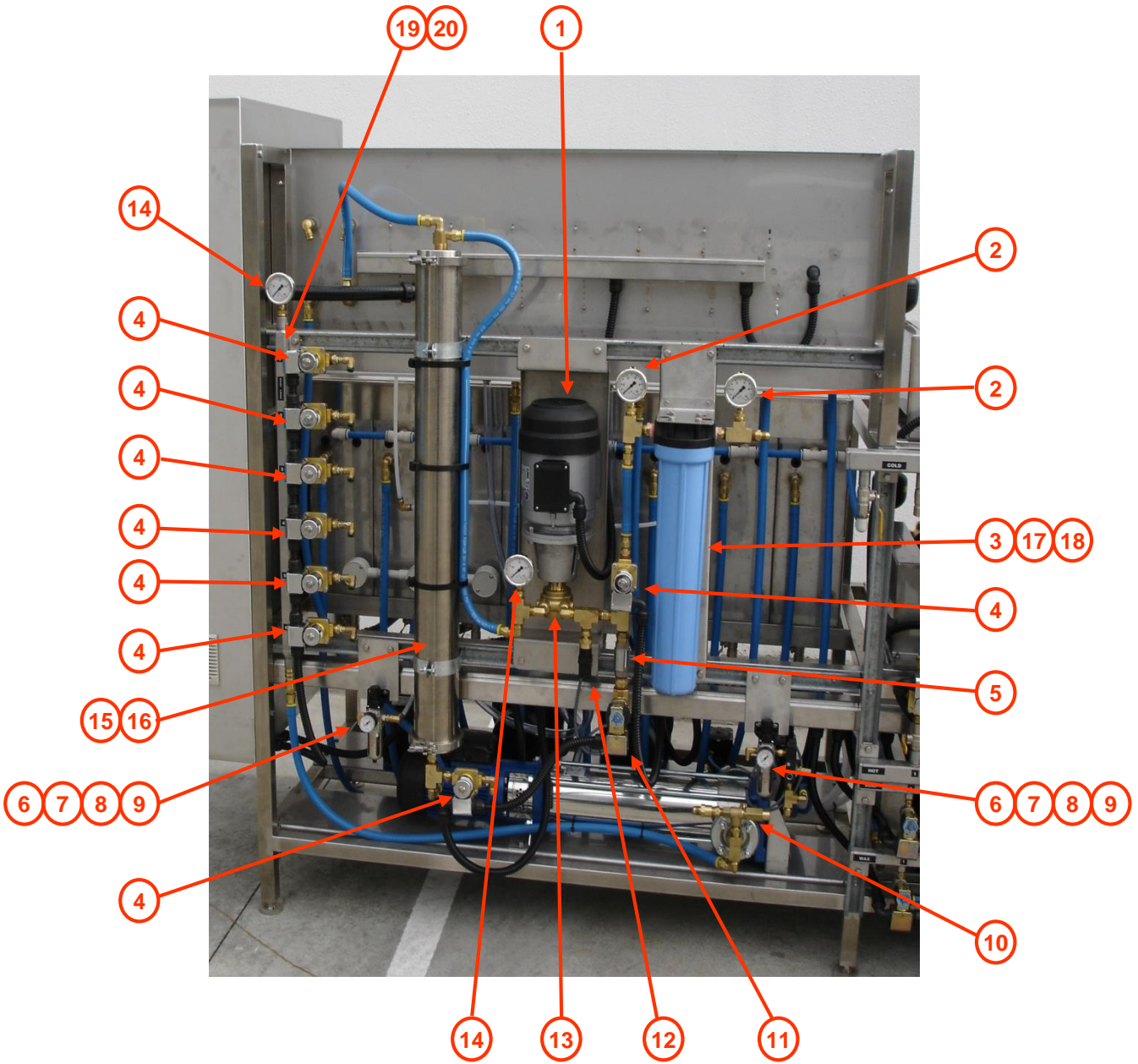



## 1800 GPD RO Pump Stand Mount – Parts List

ITEM	PART#	DESCRIPTION
1	PW10041	Motor, 3 Phase R/O (CMG)
2	DH24664	Gauge, 0-100psi
3	DH62561	Filter Housing, 20" (Amatek)
4	GC0824	Solenoid, 1/2" 24V (GC)
5	DH24912	Check Valve, 3/4" FxF S/Steel Low Pressure
6	PW10143	Regulator, Filter Air 1/4" Port AW2000 with Auto Drain
7	PW10145	Gauge, 0-1000kPa
8	PW10144	Regulator, Bowl / Guard Assembly AW2000 Auto Drain
9	PW10146	Bracket, AW2000
10	PDQ63177	Pressure Relief Valve 3/8" 350psi
11	DH18499	Solenoid, 416P 3/4" 24V (Dema)
12	PW10022	Pressure Switch, PDA, R/O & Main Water
13	PDQ62156	Pump, Procon 2508AF
14	DH24702	Gauge, 0-400psi
15	DH63519	Membrane Housing, S/Steel 4040
16	DH63512	Membrane, TW30-4040 18 (Filmtec) (Not Shown)
17	DH62526	Filter, 20" 1 Micron (Not Shown)
18	DH62527	Filter, 20" 5 Micron (Not Shown)
19	PW20051	Manifold, RO Spot Free 3 Bay (Not Shown)
20	PW20052	Manifold, RO Spot Free 6 Bay

**3600 GPD RO Wall / Floor Mount**

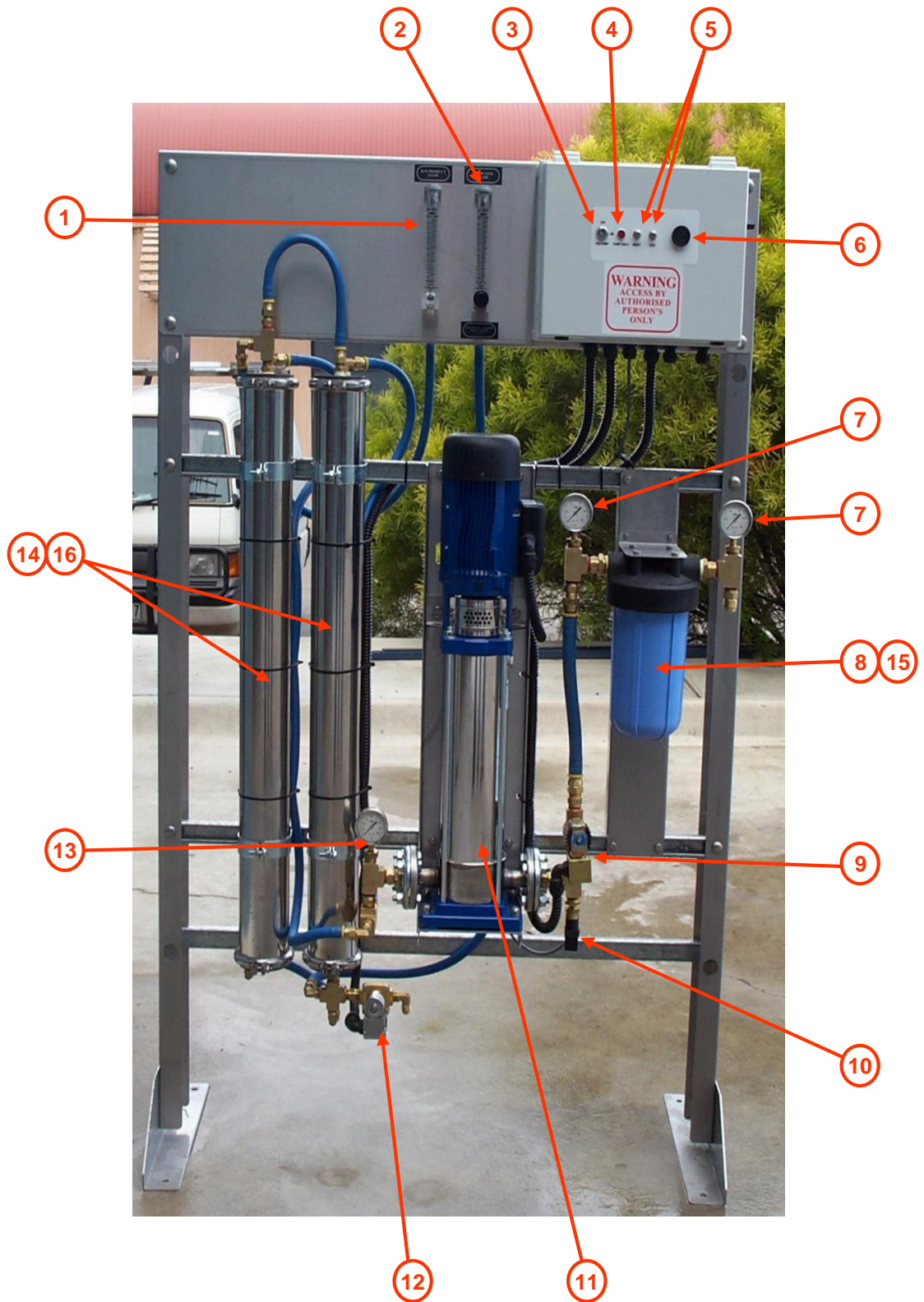

## 3600 GPD RO Wall / Floor Mount – Parts List

ITEM	PART#	DESCRIPTION
1	DH18162	Flow Meter, 0.5-5.0 GPM
2	DH18165	Flow Meter, 0.5-5.0 GPM C/W Waste Control
3	PW10001	Switch Key
4	DH73612	Lamp, Red Indicator 24V
5	DH18674	Switch, Push Button
6	DH19380	Touch Select Beeper
7	DH24664	Gauge, 0-100psi
8	DH62562	Filter Housing Big Blue 10"
9	DH18499	Solenoid, 416P 3/4" 24V (Dema)
10	PW10022	Pressure Switch, PDA, R/O & Main Water
11	PW10030	Pump, SV2-14F22T 3 Phase (Lowara)
12	GC0824	Solenoid, 1/2" 24V (GC)
13	DH24702	Gauge, 0-400psi
14	DH63519	Membrane Housing, S/Steel for 4040
15	DH62530	Filter, Big Blue Dual Gradient 25:1 Micron (Not Shown)
16	DH63512	Membrane TW30-4040 18 (Filmtec) (Not Shown)

3600 GPD RO Pump Stand Mount

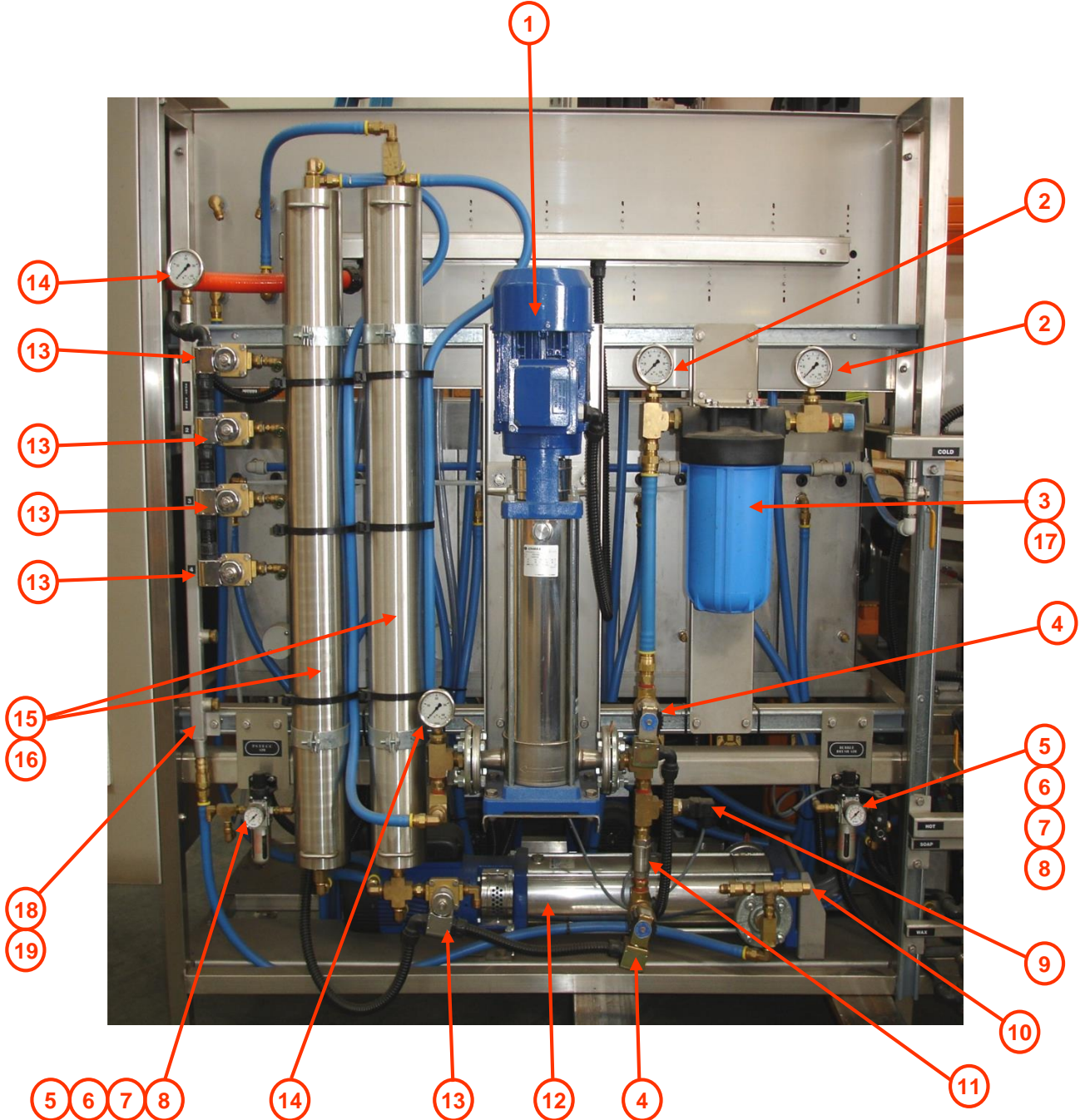

## 3600 GPD RO Pump Stand Mount – Parts List

ITEM	PART#	DESCRIPTION
1	PW10030	Pump, SV2-14F22T 3 Phase (Lowara)
2	DH24664	Gauge, 0-100psi
3	DH62562	Filter Housing, Big Blue 10"
4	DH18499	Solenoid, 416P 3/4" 24V (Dema)
5	PW10143	Regulator, Filter Air 1/4" Port AW2000 with Auto Drain
6	PW10145	Gauge, 0-1000kPa
7	PW10144	Regulator, Bowl / Guard Assembly AW2000 Auto Drain
8	PW10146	Bracket Suit AW2000
9	PW10141	Solenoid, Air 3 Port
10	PDQ63177	Pressure Relief Valve 3/8" 350psi
11	DH24912	Check Valve, 3/4" FxF S/Steel Low Pressure
12	PW10031	Pump, SV2-16F22T 3 Phase (Delivery) (Lowara)
13	GC0824	Solenoid, 1/2" 24V (GC)
14	DH24702	Gauge, 0-400psi
15	DH63519	Membrane Housing S/Steel for 4040
16	DH63512	Membrane, TW30-4040 18 (Filmtec) (Not Shown)
17	DH62530	Filter, Big Blue Dual Gradient 25:1 Micron (Not Shown)
18	PW20051	Manifold, RO Spot Free 3 Bay (Not Shown)
19	PW20052	Manifold, RO Spot Free 6 Bay

5400 GPD RO Wall / Floor Mount

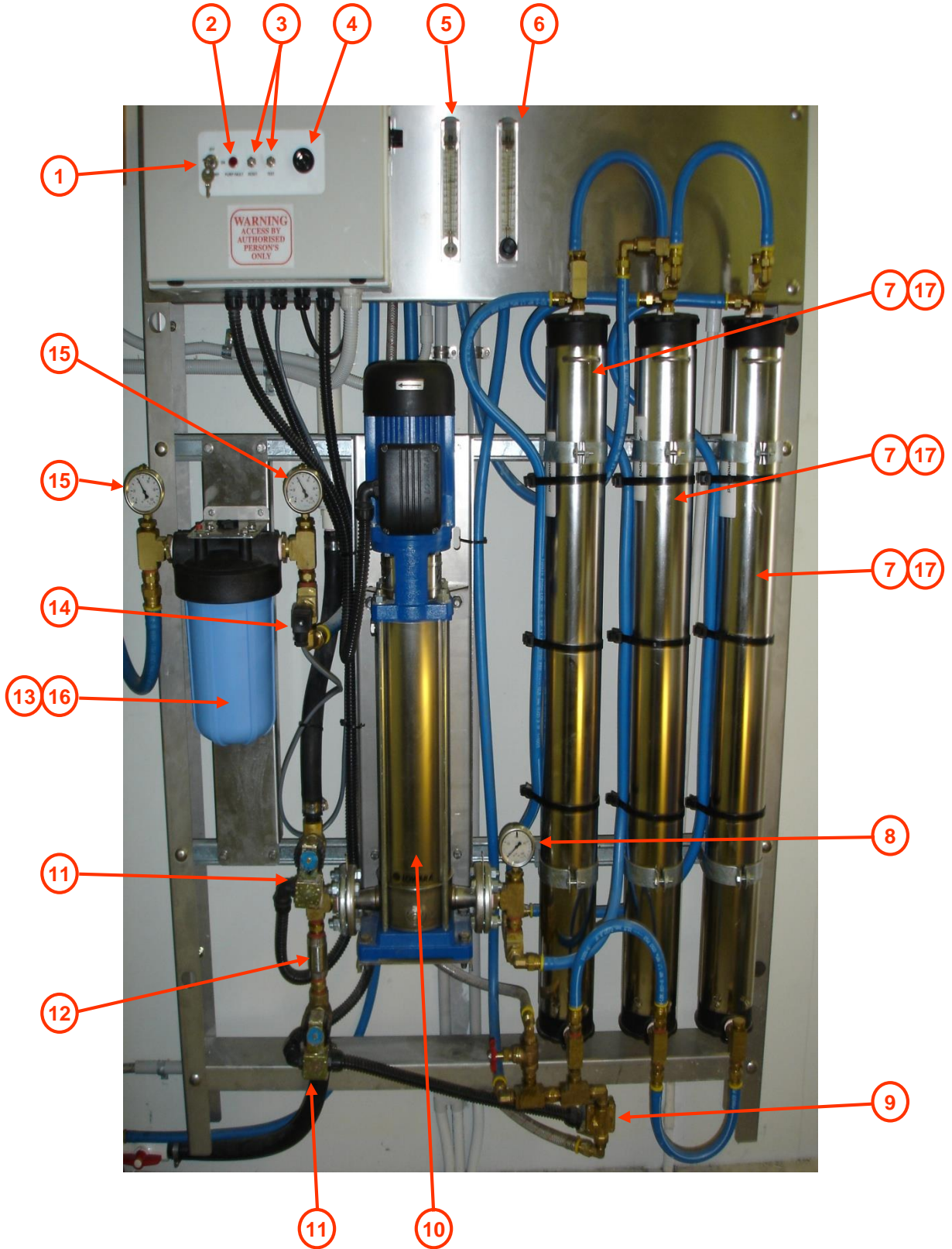

## 5400 GPD RO Wall / Floor Mount – Parts List

ITEM	PART#	DESCRIPTION
1	PW10001	Switch Key
2	DH73612	Lamp, Red Indicator 24V
3	DH18674	Switch, Push Button
4	DH19380	Touch Select Beeper
5	DH18162	Flow Meter, 0.5-5.0gpm
6	DH18165	Flow Meter, 0.5-5.0gpm C/W Waste Control
7	DH63519	Membrane Housing, S/Steel for 4040
8	DH24702	Gauge, 0-400psi
9	GC0824	Solenoid, 1/2" 24V (GC)
10	PW10030	Pump, SV2-14F22T 3 Phase (Lowara)
11	DH18499	Solenoid, 416P 3/4" 24V (Dema)
12	DH24912	Check Valve, 3/4" FxF S/Steel Low Pressure
13	DH62562	Filter Housing, Big Blue 10"
14	PW10141	Solenoid, Air 3 Port
15	DH24664	Gauge, 0-100psi
16	DH62530	Filter, Big Blue Dual Gradient 25:1 Micron (Not Shown)
17	DH63512	Membrane, TW30-4040 18 (Filmtec) (Not Shown)





## SECTION 4

# Water Heater

- Rheem Water Heater
- Raypak Water Heater





# Rheem Water Heater



ITEM	PART#	DESCRIPTION
1	PW10260	Indoor Water Heater, 621/265 H/Duty (Rheem)
2	PW10264	Indoor Water Heater, 620/260 H/Duty (Rheem) (Not Shown)
3	PW10261	Indoor Water Heater, 300/135 H/Duty Electric (Rheem) (Not Shown)

# Raypak Water Heater



## Raypak Water Heater – Parts List

ITEM	PART#	DESCRIPTION
1	PW10225	Storage Tank, 340lt (Raypak)
2	RAYPRV	Tank Pressure Relief Valve (Raypak)
3	PW10227	Hood, Indoor Kit 200
4	PW10237	Hood, Indoor Kit 280
5	PW10247	Hood, Indoor Kit 350
6	PW10257	Hood, Indoor Kit 430
7	PW10226	Tank Thermostat (Siemens)
8	RAYPRV125	Boiler Pressure Relief Valve 125psi 3/4" (Raypak)
9	PW10219	Temperature Display, Raypak 277
10	PW10229	Timer, Run On (Raypak) (Not Shown)
11	PW10224	Pump, UPS 20-60B (Grundfos)
12	PW10256	Pump, UPS 32-80180 (Grundfos)
13	PW10223	Boiler Unit, 200 LPG (Raypak)
14	PW10233	Boiler Unit, 280 LPG (Raypak)
15	PW10243	Boiler Unit, 350 LPG (Raypak)
16	PW10253	Boiler Unit, 430 LPG (Raypak)
17	PW10222	Boiler Unit, 200 NG (Raypak)
18	PW10232	Boiler Unit, 280 NG (Raypak)
19	PW10242	Boiler Unit, 350 NG (Raypak)
20	PW10252	Boiler Unit, 430 NG (Raypak)



## SECTION 5

# Air Compressor

- Fini Vertical & Horizontal
- Pilot Vertical & Horizontal
- Peerless Vertical & Horizontal







# Finì Vertical & Horizontal Air Compressor

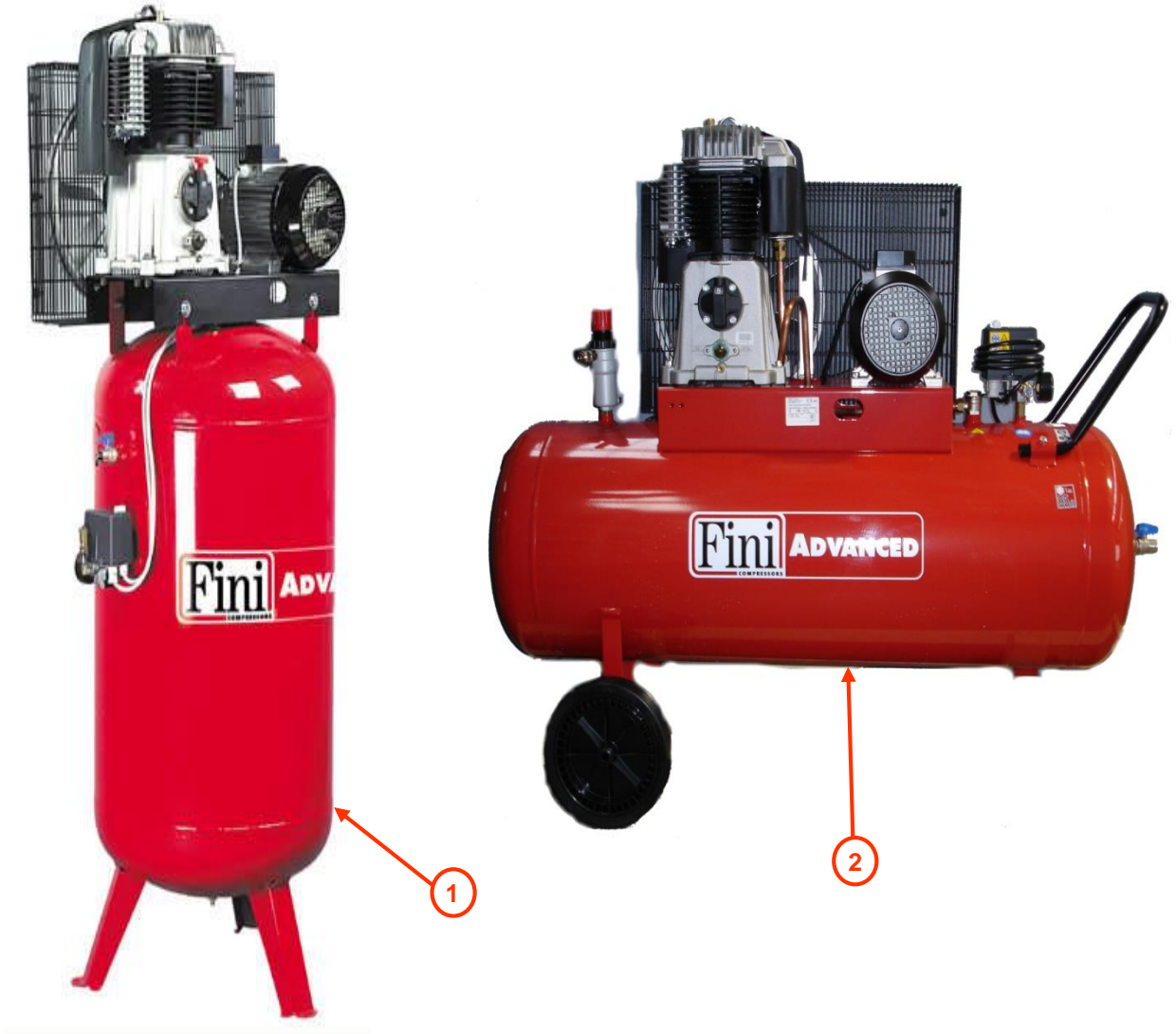

ITEM	PART#	DESCRIPTION
1	FC55270V	Compressor, Vertical 5.5hp
2	FC55200H	Compressor, Horizontal 5.5hp

# Pilot Vertical & Horizontal Air Compressor



1



2 3

ITEM	PART#	DESCRIPTION
1	PW40441	Compressor, 3 Phase Vertical 176lt (4kw)
2	PW40409	Compressor, 3 Phase Horizontal 147lt (4kw)
3	PW40440	Compressor, 3 Phase Horizontal 216lt (4kw)

## Peerless Vertical & Horizontal Air Compressor



1



2

ITEM	PART#	DESCRIPTION
1	PW40452	Compressor, 3 Phase Horizontal 150lt
2	PW40453	Compressor, 3 Phase Vertical 200lt



## **SECTION 6**

# **Mains Water Re-Pressure System**

- Lowara Pump
- Hydrovar Pump
- Hydropac





# Lowara Pump

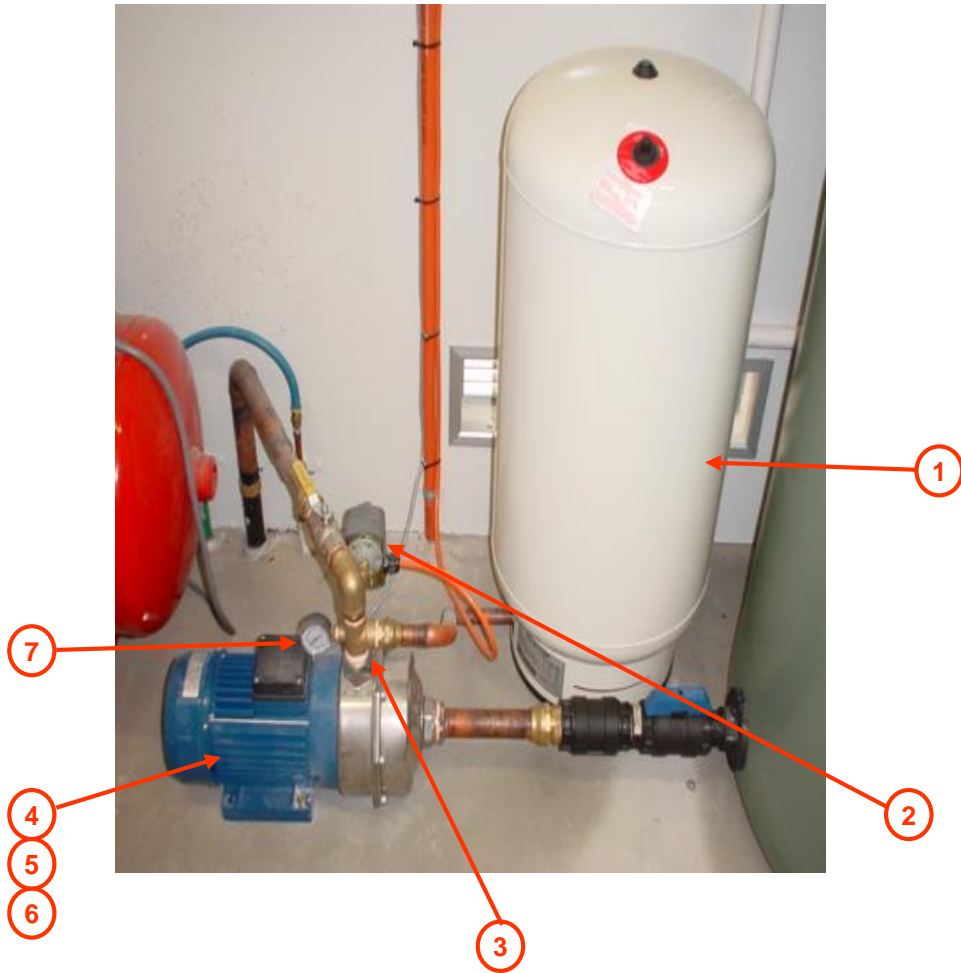

ITEM	PART#	DESCRIPTION
1	PW10043	Pressure Tank, 99lt
2	PW10038	Pressure Switch, XMP 12 Bar
3	PW10036	5-Way Connector, SM Motor
4	PW10035	Pump, CA-200/35V (Lowara)
5	PW10053	Pump, CA-120/35V (Lowara)
6	PW10057	Pump, CA-200/33V (Lowara)
7	PW10037	Gauge, 63mm 0-600kPa

# Hydrovar Pump

Wall Mount



Vertical



ITEM	PART#	DESCRIPTION
1	PW10033	Wall Mount Hydrovar, 3.2
2	PW10034	Pressure Tank, JR25, 32lt
3	PW10097	Pressure Tank, JR15, 17lt
4	PW10053	Pump, CA-200/35V (Lowara)
5	PW10058	Transducer, Hydrovar 0-10 Bar
6	PW10096	Pump, SV1602 Hydrovar 415V 3 Phase (Lowara)
7	PW10092	Pump, SV1603 Hydrovar 415V 3 Phase (Lowara)



# Hydropac

(Comes mounted on steel frame with pressure tank, all one piece)



ITEM	PART#	DESCRIPTION
1	PW10095	Pump, SV1602 415V 3 Phase (Hydropac)
2	PW10091	Pump, SV1603 415V 3 Phase (Hydropac)



## SECTION 7

# Vacuums

- Power Vac Vacuum
- Mega Vac / Fragrance Combo





# Power Vac Vacuum

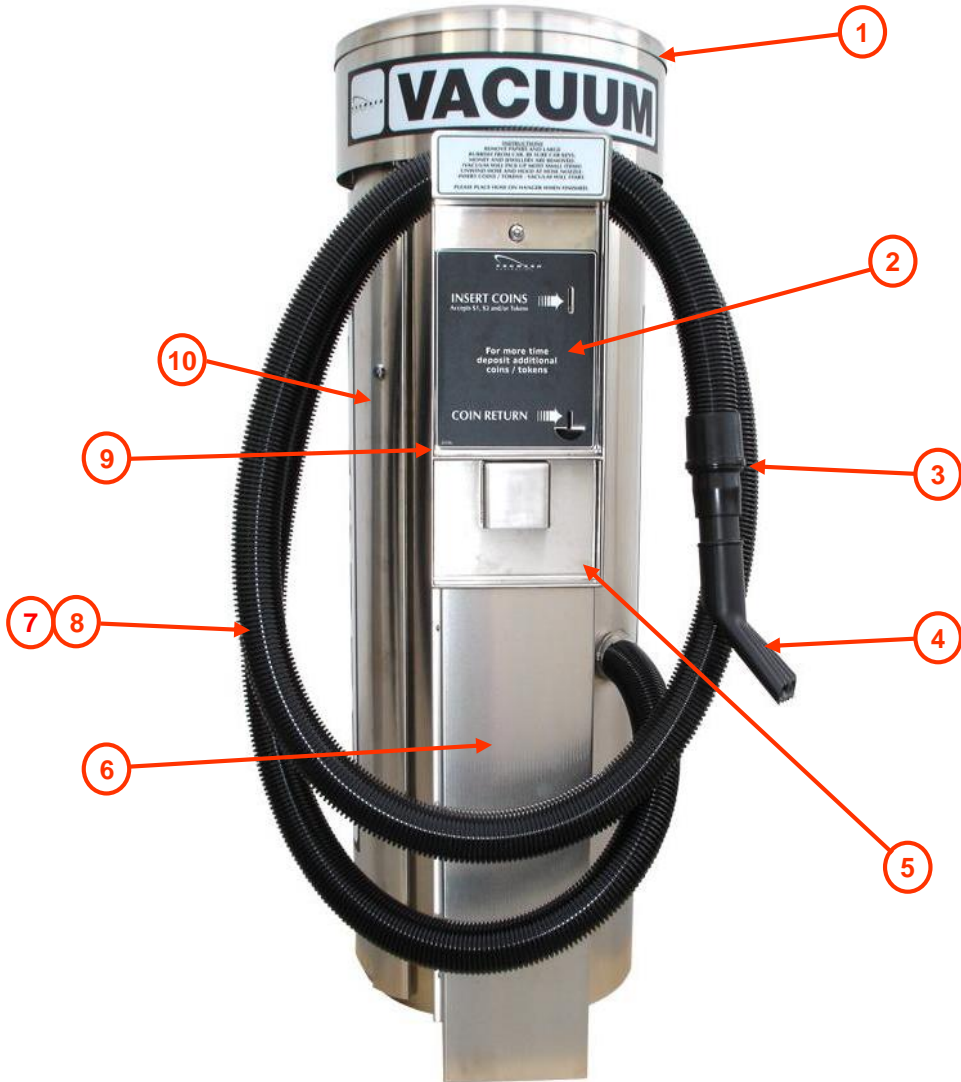

ITEM	PART#	DESCRIPTION
1	PW40416	Dome Assembly
2	DH40134	Vacuum Coin Door
3	DH20232	Vacuum Swivel Cuff 2" Black
4	DH20254	Vacuum Nozzle 2" Black
5	PW40421	Vacuum Safe Door
6	PW40418	Vacuum Lower Front Cover
7	DH20235	Vacuum Hose 2" x 15ft Black
8	DH20236	Vacuum Hose 2" x 50ft Black
9	PW40419	Vacuum Main Control Box
10	PW40417	Vacuum Main Access Door with Brackets

## Power Vac Vacuum – Spare Parts



1



3



2

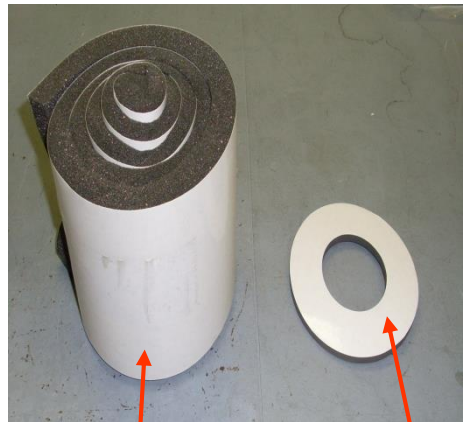

4

5

ITEM	PART#	DESCRIPTION
1	DH20391	Vacuum Motor, Lamb Accustek 240V (Quiet)
2	DH20446	Vacuum Waste Bucket
3	DH20207	Vacuum Motor Brushes (Lamb)
4	DH20374	Vacuum, Acoustic Foam for S/Steel Dome
5	DH20373	Vacuum Motor Gasket

## Power Vac Vacuum – Spare Parts

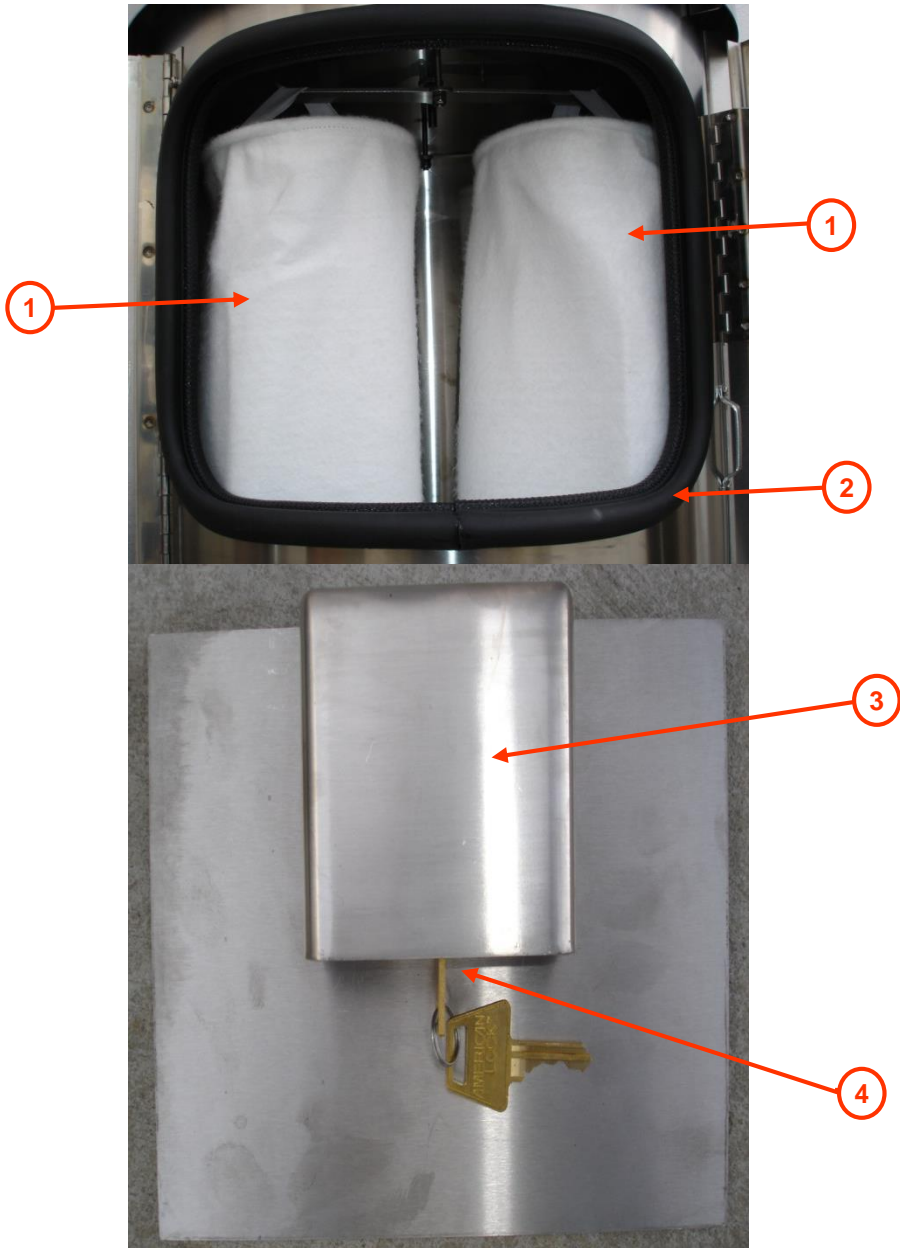

ITEM	PART#	DESCRIPTION
1	DH31255	Vacuum Filter Bag
2	PW10019	Vacuum Door Seal, Pinch Weld
3	PW40421	Vacuum Safe Door
4	DH23018	Lock, American 2000

# Power Vac Vacuum Decals

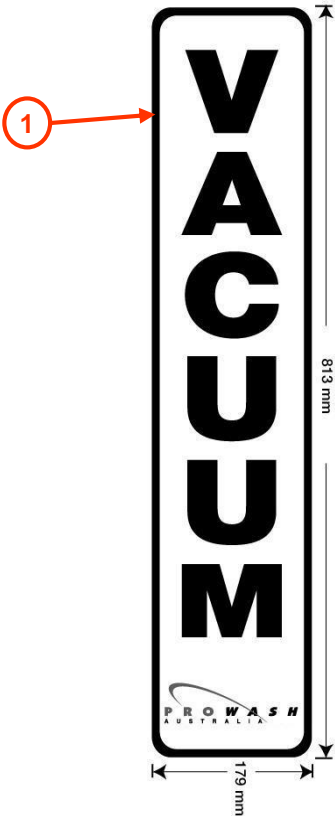

ITEM	PART#	DESCRIPTION
1	DH21371	Vacuum Canister Decal
2	DH21351	Vacuum Instruction Decal
3	DH21356	Vacuum Coin Door Decal
4	DH21370	Vacuum Dome Decal



# Power Vac Vacuum Coin Door Internal

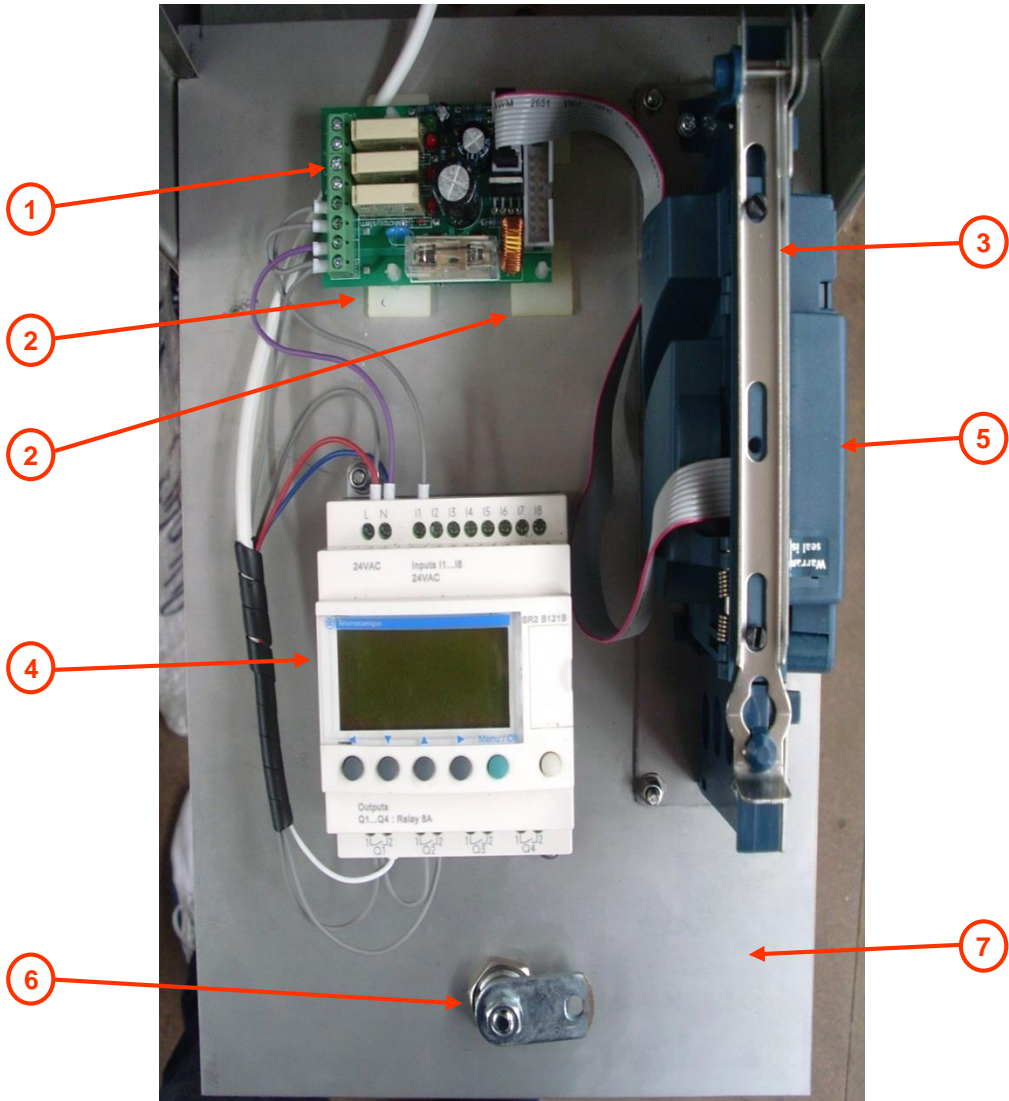

ITEM	PART#	DESCRIPTION
1	MC6003431	Microcoin VAL 343 Interface Board
2	MC04258455	Microcoin Interface Board Support
3	MC5402000	Microcoin Retrofit Bracket 2"
4	PW10209	Vacuum Timer, SR2 Zelio
5	MC93367810	Microcoin QL Coin Acceptor (Top Entry)
6	PW20047	Vacuum Lock & Key
7	DH40134	Vacuum Coin Door

**Please note that this is the new version of the Vacuum Timer SR2.  
Please see next page for older version diagram.**

**Old Version Vacuum Timer SR1**

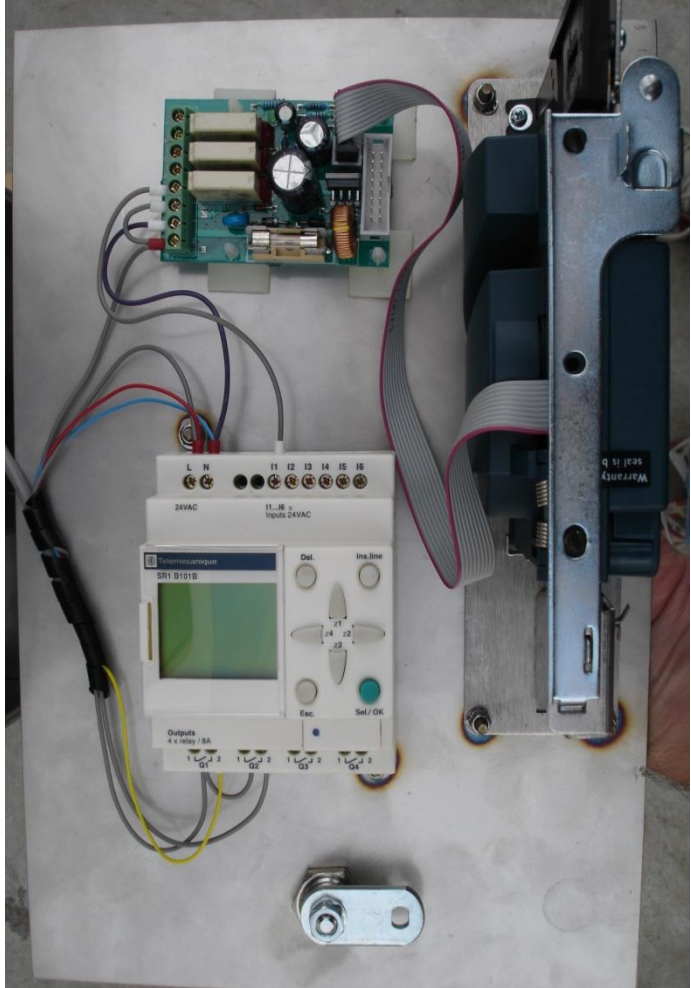

# Power Vac Vacuum Electrical Box Internal

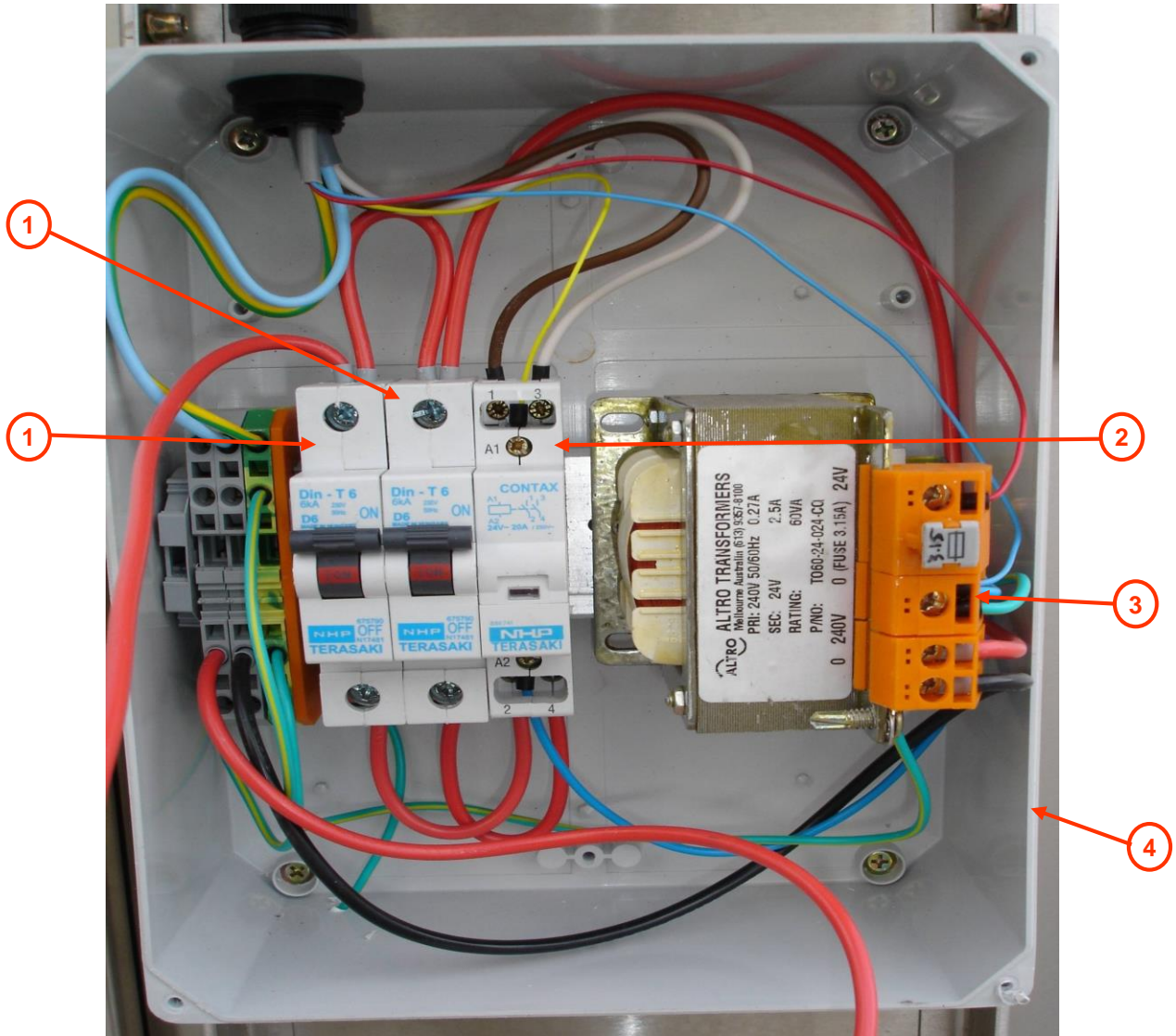

ITEM	PART#	DESCRIPTION
1	PW10132	Vacuum Circuit Breaker 6 Amp
2	PW10133	Vacuum Contactor 2 Pole
3	PW10020	Transformer, 240V - 24V 60VA Din Rail Mount
4	PW10131	Vacuum Enclosure PVC

Mega Vac / Fragrance Combo

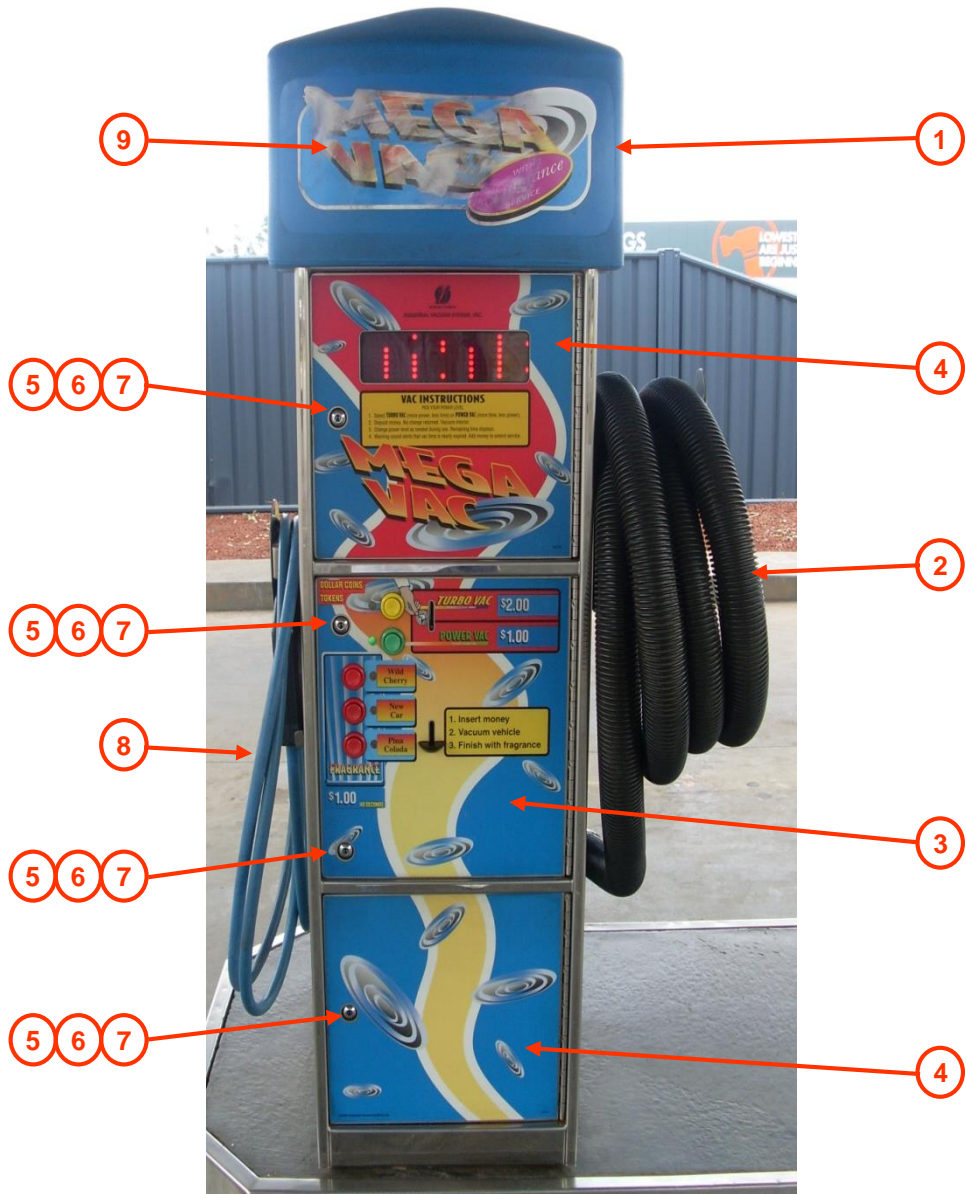

## Mega Vac / Fragrance Combo – Parts List

ITEM	PART#	DESCRIPTION
1	VL502504	Mega Vac Dome
2	DH20235	Mega Vac Vacuum Hose - Black
3	VL532305	Mega Vac / Fragrance Combo Middle Door Decal
4	VL522315	Mega Vac Top & Bottom Door Decal
5	VLMEGAKEY	Mega Vac Key (Front x 3 Doors)
6	VLMEGALOCK	Mega Vac Lock Only (Front x 3 Doors)
7	VLMEGACAM	Mega Vac Key Lock Cam Only (Front x 3 Doors)
8	VL504513	Mega Vac Tubes & Wires for Hose & Gun
9	VLS532305A	Mega Vac / Fragrance Combo Dome Front Decal
10	VL522303	Mega Vac Dome Sides Decal (Not Shown)
11	DH20232	Mega Vac Vacuum Swivel Cuff - Black 2" (Not Shown)
12	DH20254	Mega Vac Vacuum Nozzle (Black plastic) (Not Shown)
13	VL508202	Mega Vac / Fragrance Combo Gun Only (Not Shown)
14	VL508205	Mega Vac / Fragrance Combo Gun & Hose Complete (Not Shown)
15	VL522320	Mega Vac Side Decals (Set) (Not Shown)

Mega Vac / Fragrance Combo Internal

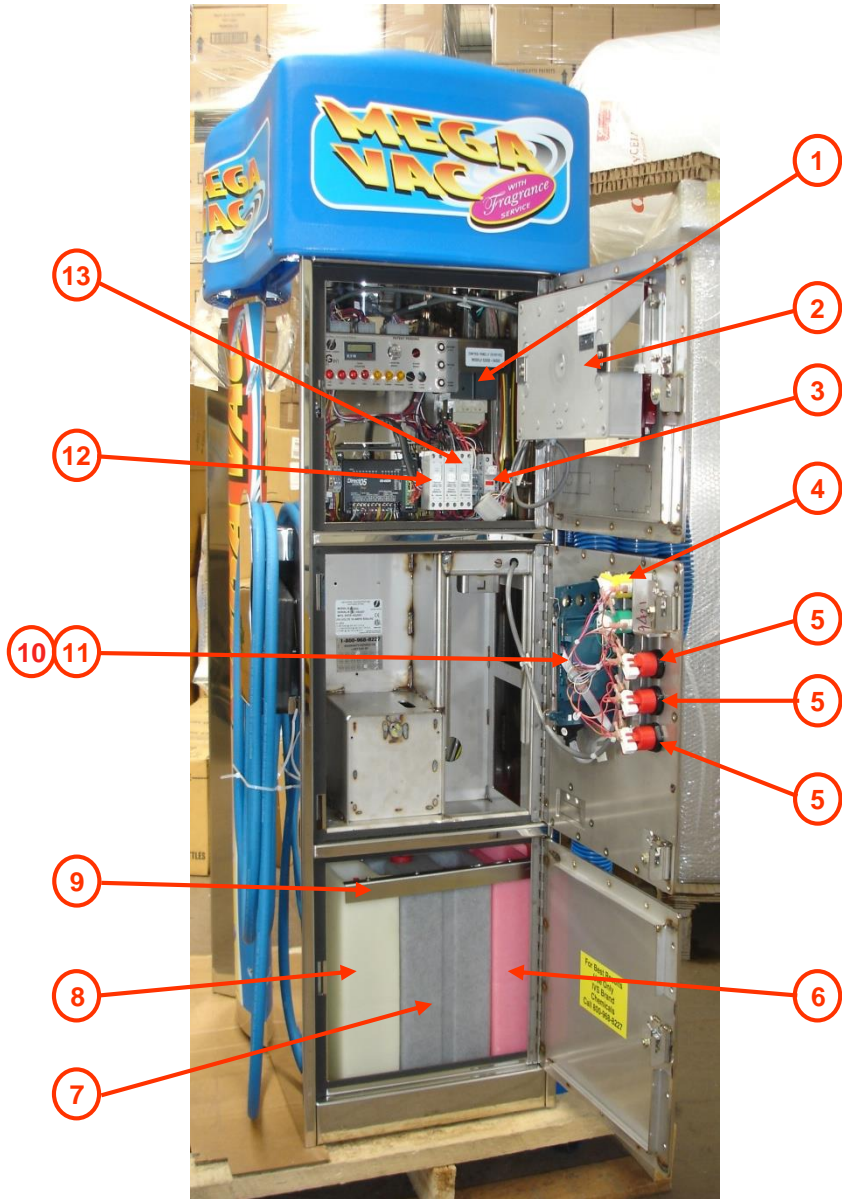

## Mega Vac / Fragrance Combo Internal – Parts List

ITEM	PART#	DESCRIPTION
1	VL107808	Mega Vac Transformer, 115/208/230V to 24V 100VA 4 Amp
2	VL528000	Mega Vac / Fragrance Combo Display Timer
3	VL522700	Mega Vac Fuse, Main Power 30 Amp
4	VL507706	Mega Vac Switch, Push Button Yellow
5	VL507705	Mega Vac Switch, Push Button Red
6	VL507907	Mega Vac / Fragrance Combo Tank #3 Red
7	VL507906	Mega Vac / Fragrance Combo Tank #2 Black
8	VL507905	Mega Vac / Fragrance Combo Tank #1 Yellow
9	VL501015	Mega Vac / Fragrance Combo Bracket for Tanks
10	MC93367810	Microcoin QL Coin Acceptor (Top Entry)
11	MC5402000	Microcoin Retrofit Bracket 2"
12	VL526200	Mega Vac Relay, Solid State Heat Sink Mounted 30 Amp
13	VL526203	Mega Vac Relay, Solid State Heat Sink Mounted 20 Amp

# Mega Vac / Fragrance Combo Dome Internal

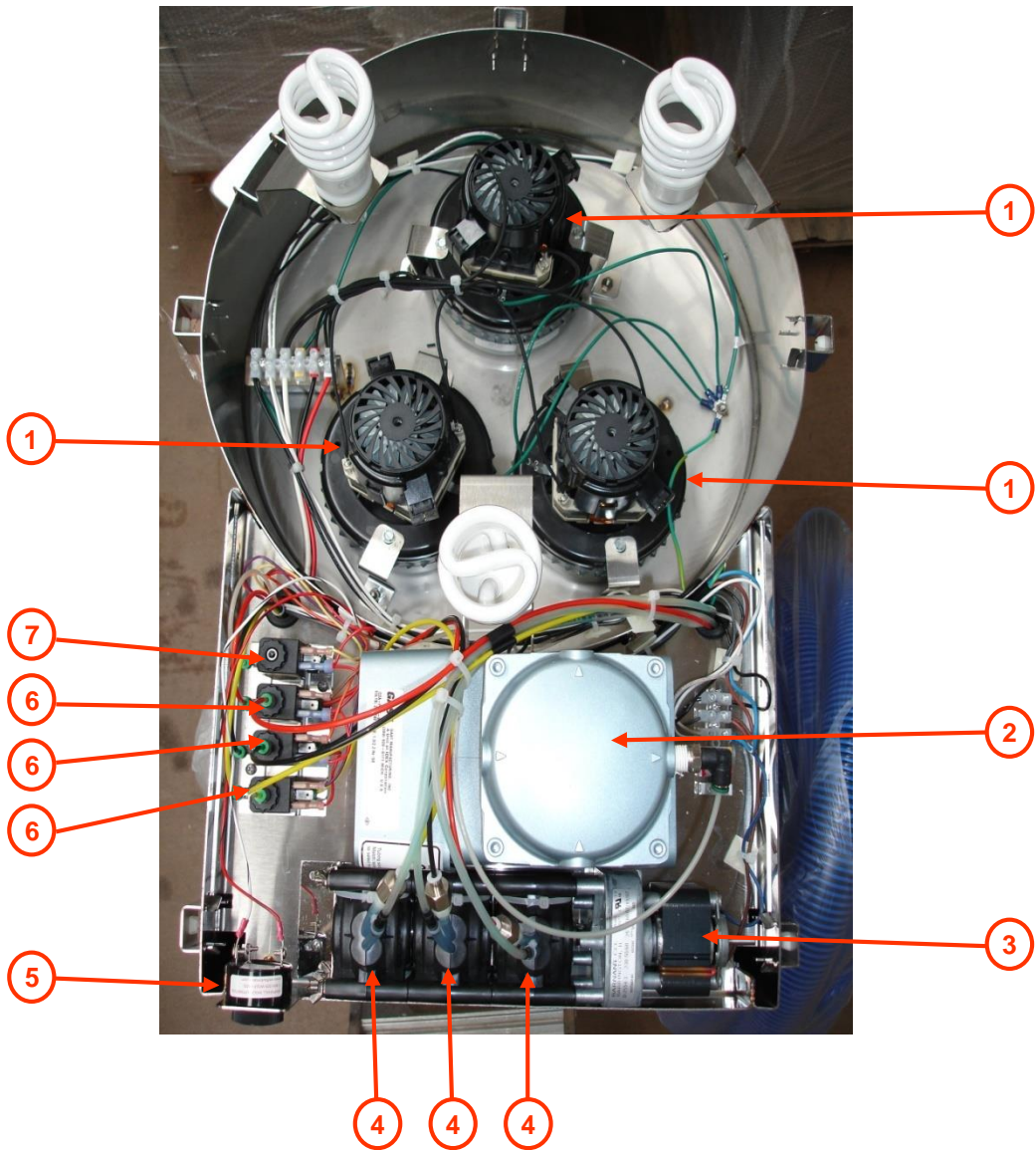

ITEM	PART#	DESCRIPTION
1	DH20390	Vacuum Motor - Lamb Standard 240V
2	VL501705	Mega Vac Compressor 240V
3	VL504523	Mega Vac / Fragrance Combo Pump, Delivery Peristaltic
4	VL504523TUBE	Mega Vac / Fragrance Combo Tube for Peristaltic Pump
5	DH19380	Touch Select Beeper
6	VL504516	Mega Vac, Single Valve Assembly w/Fittings Solution Delivery
7	VL504517	Mega Vac, Single Valve Assembly w/Fittings Compressor



**Mega Vac / Fragrance Combo Rear View**

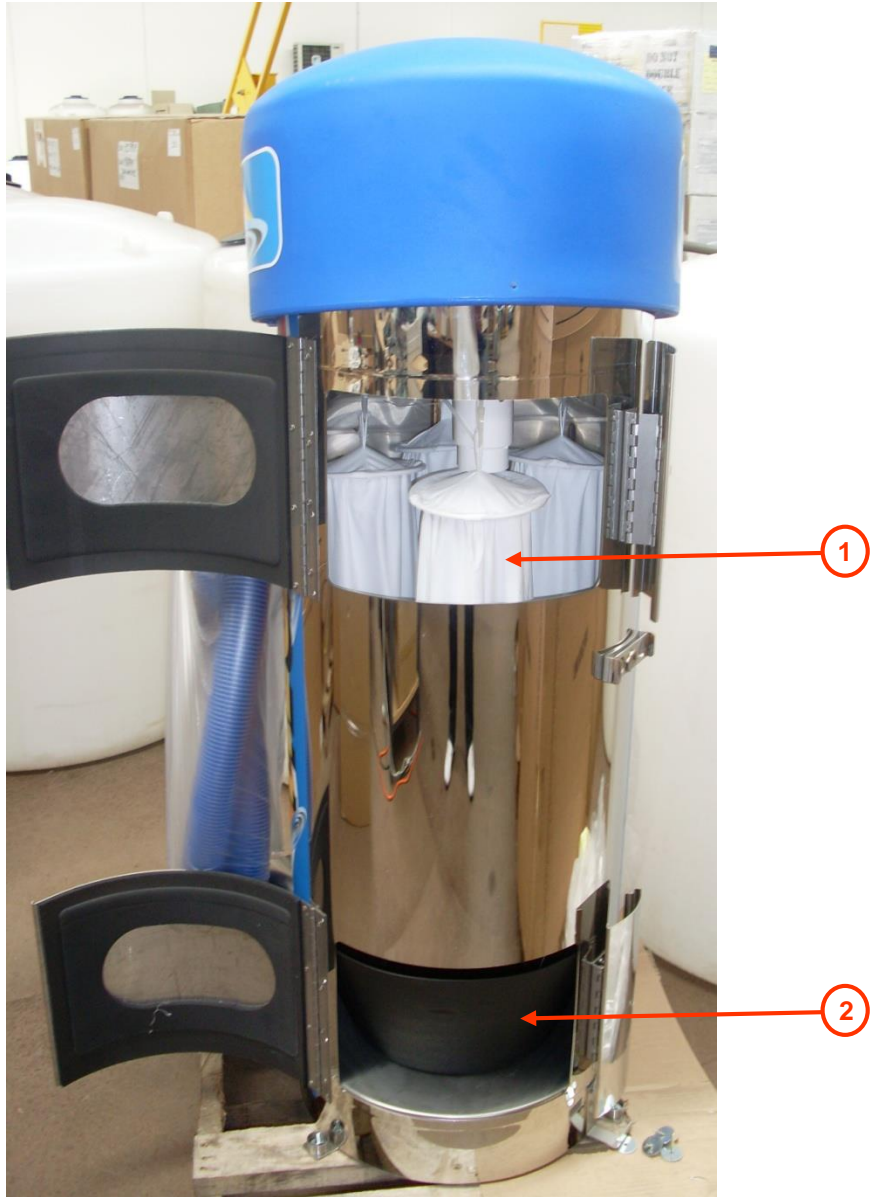

ITEM	PART#	DESCRIPTION
1	DH31255	Vacuum Filter Bag
2	VL500702	Mega Vac Waste Bucket

## Mega Vac / Fragrance Combo – Spare Parts List

PART#	DESCRIPTION
MC93367810	Microcoin QL Coin Acceptor (Top Entry)
DH20232	Mega Vac Vacuum Swivel Cuff - Black 2"
VL103301	Mega Vac Foam Motor Gasket
DH20221	Mega Vac Vacuum Hose - Blue/Black
VL104710	Mega Vac Lock Hasp
VL104712	Mega Vac Latchless Lock
DH20390	Vacuum Motor - Lamb Standard 240V
VL106006	Mega Vac / Fragrance Combo Plastic Plug 1.44" for Tanks
VL107808	Mega Vac Transformer, 115/208/230V to 24V 100va 4 Amp
DH20254	Mega Vac Vacuum Nozzle (Black plastic)
VL500702	Mega Vac Waste Bucket
VL500801	Mega Vac Fragrance Gun Atomiser
VL501015	Mega Vac / Fragrance Combo Bracket for Tanks
VL501705	Mega Vac Compressor 240V
VL502504	Mega Vac Dome
VL502710	Mega Vac Circuit Breaker Thermal 8 Amp
VL502711	Mega Vac Circuit Breaker Thermal 15 Amp
VL502713	Mega Vac Main Power Fuse
DH31255	Vacuum Filter Bag
VL504512	Mega Vac Pick-Up Tube Kit (Tanks to Pump)
VL504513	Mega Vac / Fragrance Combo Tubes & Wire Kit (Hose & Gun)
VL504515	Mega Vac / Fragrance Combo Peristaltic Pump Assembly w/Fittings
VL504516	Mega Vac / Fragrance Combo Solution Delivery Kit w/Fittings
VL504517	Mega Vac / Fragrance Combo Compressor Kit w/Fittings
VL504523	Pump, Fragrance Delivery Peristaltic
VL507705	Switch, Push Button Red
VL507706	Switch, Push Button Yellow
VL507905	Tank Fresh N Up #1 Yellow

## Mega Vac / Fragrance Combo – Spare Parts List Cont.

PART#	DESCRIPTION
VL507906	Tank Fresh N Up #2 Black
VL507907	Tank Fresh N Up #3 Red
VL508202	Tool, Gun Complete (Excludes Hose)
VL508205	Tool, Gun & Hose Complete
VL508703	Solenoid
VL522303	Mega Vac Dome Sides Decal
VL522315	Mega Vac Top & Bottom Door Decal
VL522320	Mega Vac Side Decals (Set)
VL522700	Fuse, Main Power FNQ - 30 Amp, Mega Vac
VL522703	Fuse, Timer ABC - 2 Amp
VL522706	Fuse, (Holder Only) with LED 110V 22 - 12awg
VL522707	Fuse, (Holder Only) with LED 24V 22 - 12awg
VL522712	Fuse, Transformer ABC - 4 Amp
VL524605	Lamp, Red LED Chassis Panel 125V
VL524606	Lamp, Yellow LED Chassis Panel 24V
VL524607	Lamp, Red Extra-Brite LED Chassis Panel 28V
VL524608	Lamp, Yellow Extra-Brite LED Chassis Panel 28V
VL526200	Relay, Solid State Heat Sink Mounted 30 Amp
VL526203	Relay, Solid State Heat Sink Mounted 20 Amp
VL528000	Timer, Big-Time Display Two Timer
VL528001	Timer, Big-Time Display Two Timer
VL530007	Mega Vac / Fragrance Combo Complete with Microcoin QL
VL532305	Mega Vac / Fragrance Combo Middle Door Decal
VLMEGACAM	CAM Only Outside Doors - Mega Vac
VLMEGAKEY	Key Only Outside Doors - Mega Vac
VLMEGALOCK	Lock Only Outside Doors - Mega Vac



## SECTION 8

# Fragrance Machine

- Internal Components
- External Components





# Fragramatics Fragrance Machine



ITEM	PART#	DESCRIPTION
1	NSTK13	Fragramatics Fragrance Gun Holder
2	DH13137	Fragramatics Visual Display Fluid Red
3	DH13135	Fragramatics Visual Display Fluid Yellow
4	DH13138	Fragramatics Visual Display Fluid Orange
5	DH29617	Fragramatics Fragrance Machine Decal
6	DH29205	Fragramatics Fragrance Stand Galvenised
7	DH29150	Fragramatics Fragrance Safe Tray Housing
8	DH23000	Abus Padlock
9	DH29149	Fragramatics Fragrance Safe Tray
10	DH29181	Fragramatics Fragrance Gun & Hose Assembly

## Fragramatics Fragrance Machine Cabinet Internal



ITEM	PART#	DESCRIPTION
1	GS77108	Timer, GS401 (Replaces DH77054 - GS8 & DH77088 -GS87)
2	DH29172	Fragramatics Pick Up Tube
3	DH29190	Fragramatics Fragrance Solenoid
4	DH29175	Fragramatics Fragrance Air Pump 240V
5		Solenoid Air 3 Port
6	DH29174	Fragramatics Fragrance Machine 1/2 Gal Bottle
7	SR7500	Fragramatics Fragrance Air Pump for Visual Display (Upgraded to Single Pump)



# Fragramatics Fragrance Machine Front Door Internal

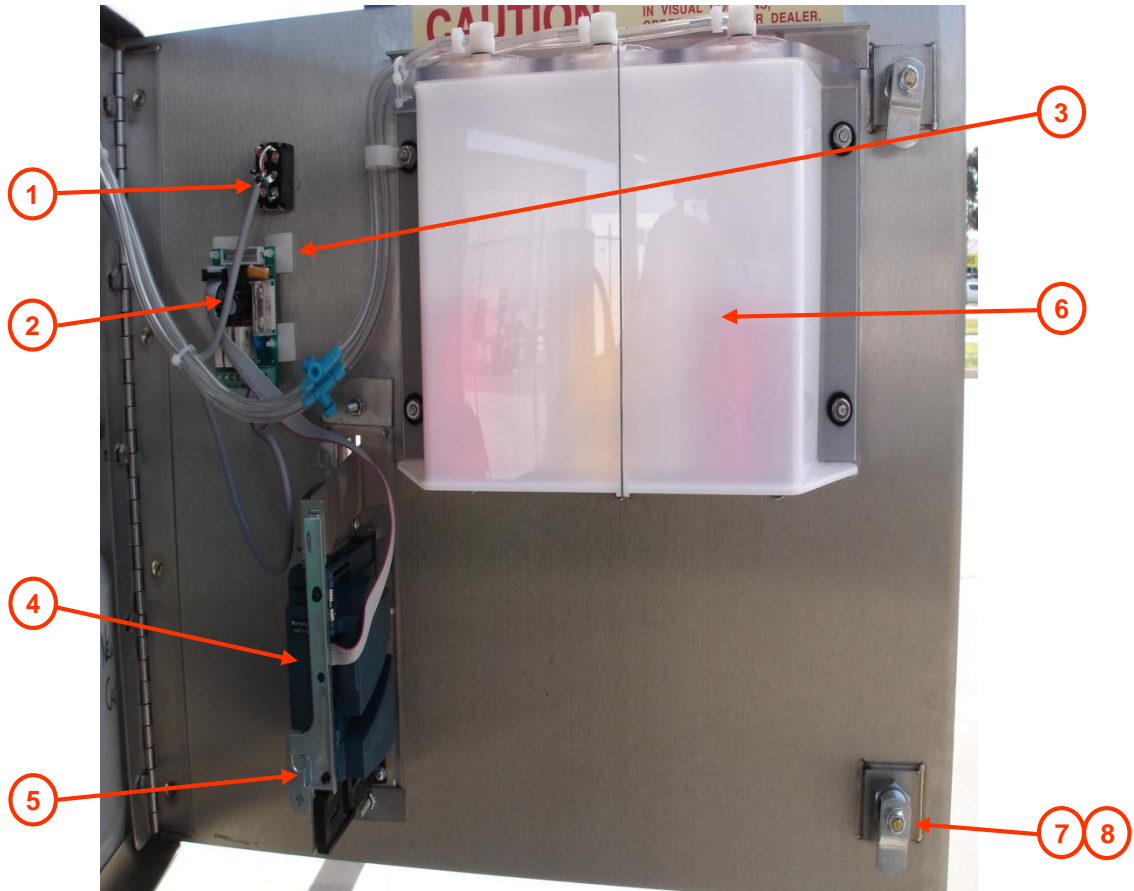

ITEM	PART#	DESCRIPTION
1	DH18712	Fragramatics Fragrance Selector Switch 3 Column
2	MC6003431	Microcoin VAL 343 Interface Board
3	MC04258455	Microcoin Interface Board Support
4	MC93367810	Microcoin QL Coin Acceptor (Top Entry)
5	MC54020000	Microcoin Retrofit Bracket 2"
6	DH29165	Fragramatics Fragrance Visual Display unit 3 Column
7	DH29146	Fragramatics Key for Combo Lock (Not Shown)
8	DH29145	Fragramatics Combo Lock

# Fragramatics Fragrance Machine Gun



ITEM	PART#	DESCRIPTION
1	DH29184	Fragramatics Fragrance Atomiser for 3 column (Not Shown)
2	DH29195	Fragramatics Fragrance Switch Push Button
3	DH29198	Fragramatics Fragrance Hose with Tubes
4	DH29168	Fragramatics Fragrance Gun Handle

## SECTION 9

# Change Machine

- Anztec QC5000
- Anztec QC5500
- Anztec QC5502

**ANZTEC** **Microcoin<sup>®</sup>**



# QC5000 Change Machine



ITEM	PART#	DESCRIPTION
1	MC93367810A	Microcoin QL Coin Acceptor for Change Machine (Top Entry)
2	QC5000DECNEW	Change Machine QC5000 Decal
3	QCGBAHOR	Note Acceptor HR-1

## QC5000 Change Machine Internal

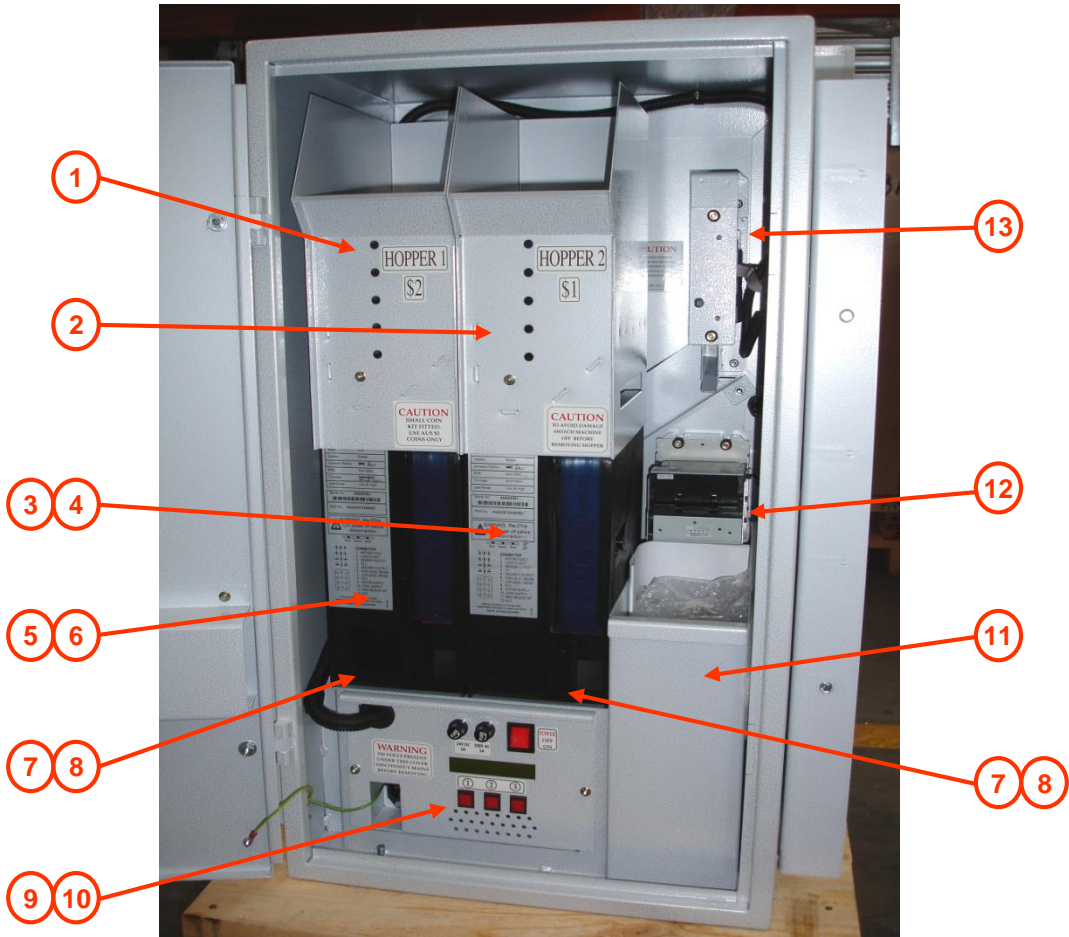

ITEM	PART#	DESCRIPTION
1	QC5000SHUTE2	Extended Coin Chute \$2 coins
2	QC5000SHUTE1	Extended Coin Chute \$1 coins
3	QCMK25000-01	Coin Hopper Change Machine - \$1 MK 2 (Not Shown)
4	QCMK45000-01	Coin Hopper Change Machine - \$1 MK 4
5	QCMK25000-02	Coin Hopper Change Machine - \$2 MK 2 (Not Shown)
6	QCMK45000-02	Coin Hopper Change Machine - \$2 MK 4
7	QCMK2SLIDE	Hopper Slide, MK 2 Conversion (Not Shown)
8	QCMK4SLIDECHG	Hopper Slide MK 4
9	QC5000PSUP	Power Supply, QC5000 MK 1 (Small) (Not Shown)
10	QC5000PSUP2	Power Supply, QC5000 MK 2 (Big)
11	QC5000BIN	Money Bin QC5000
12	QCGBAHOR	Note Acceptor HR-1
13	MC93367810A	Microcoin QL Coin Acceptor for Change Machine (Top Entry)

# QC5500 Change Machine

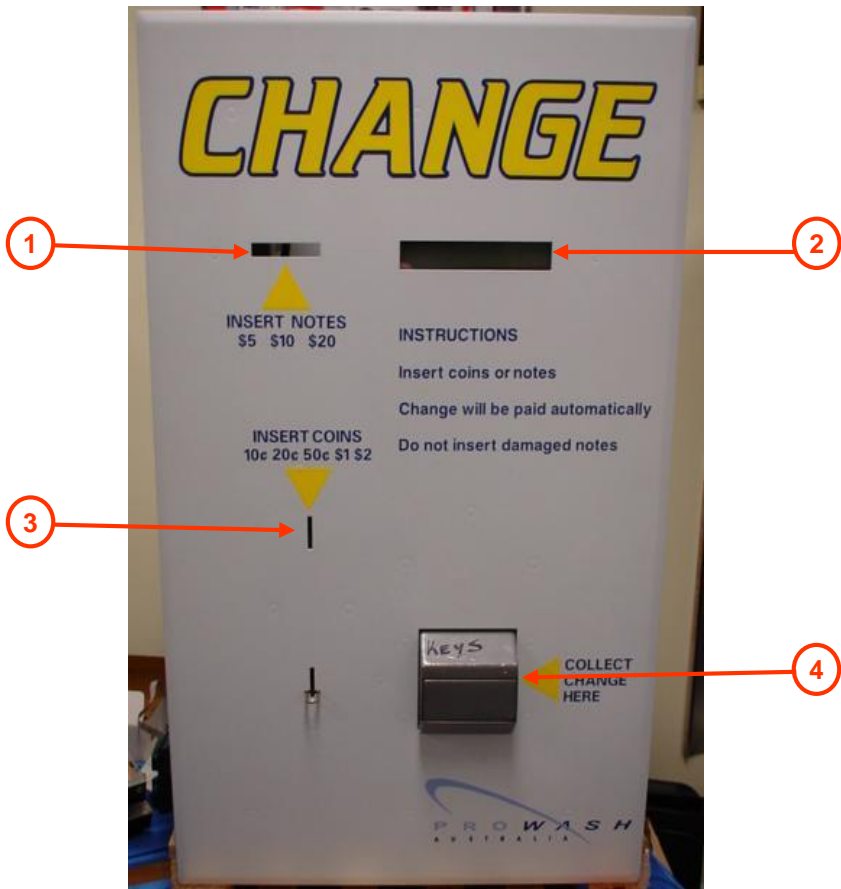

ITEM	PART#	DESCRIPTION
1	QCGBAHOR	Note Acceptor HR-1
2	QCCUSTLCD	Screen, Customer Display (5500/5502/5950)
3	MC93367810A	Microcoin QL Coin Acceptor for Change Machine (Top Entry)
4	QC5502CHUTE	Coin Chute (5500/5502)

# QC5502 Change Machine

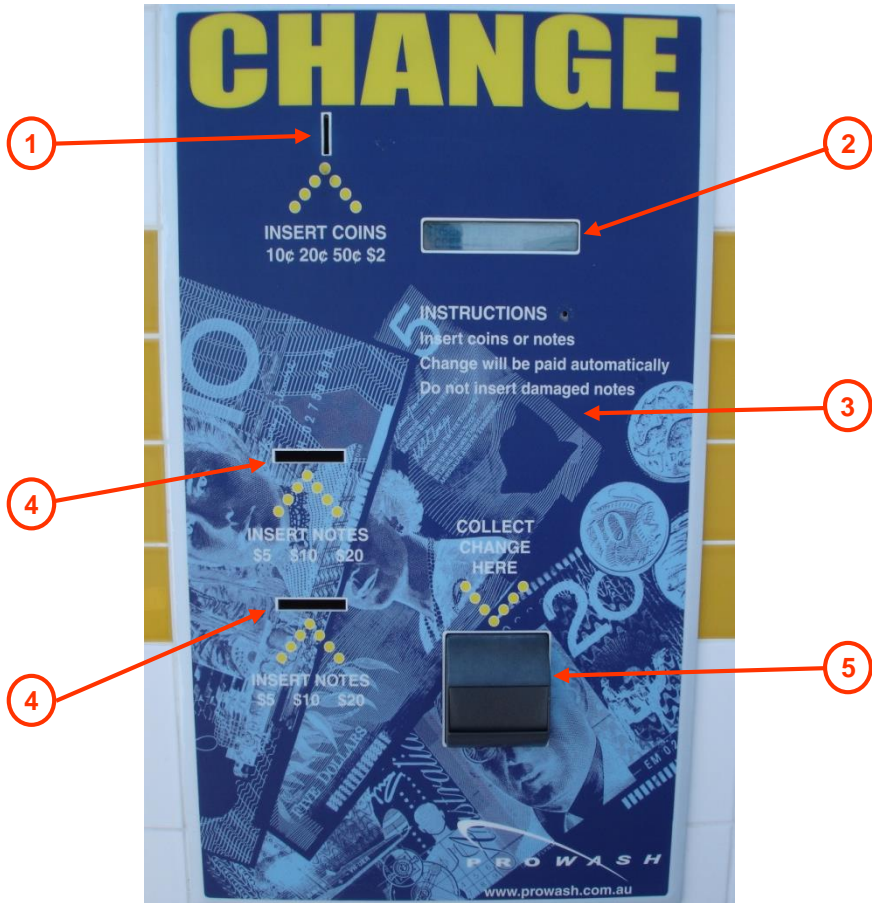

ITEM	PART#	DESCRIPTION
1	MC93367810A	Microcoin QL Coin Acceptor for Change Machine (Top Entry)
2	QCCUSTLCD	Screen, Customer Display (5500/5502/5950)
3	QC5502DEC	Change Machine QC5502 Decal
4	QCGBAHOR	Note Acceptor HR-1
5	QC5502CHUTE	Coin Chute (5500/5502)



# QC5502 Change Machine Internal

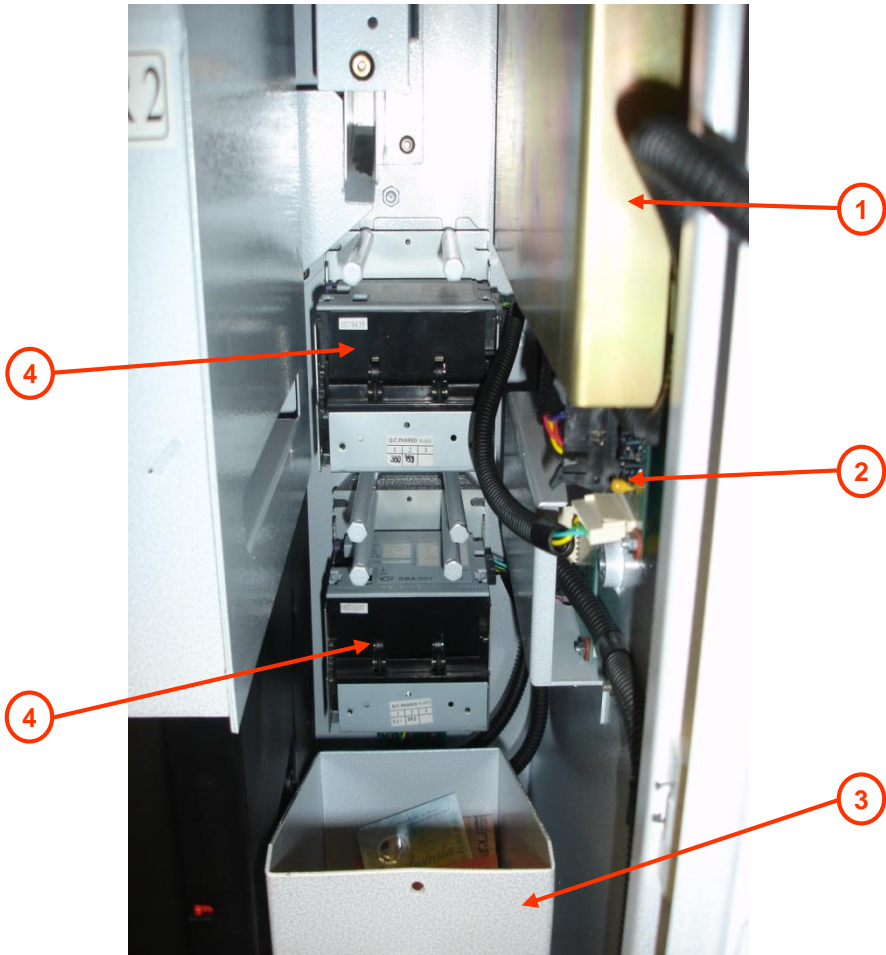

ITEM	PART#	DESCRIPTION
1	QC5502LOGIC	Logic Board Complete QC5502 (2 Boards & Mounting Frame)
2	QCRS232	Interface Board RS232 (5000/5500/5502)
3	QC5502BIN	Money Bin (QC5502)
4	QCGBAHOR	Note Acceptor HR-1

**QC5502 Change Machine Internal**

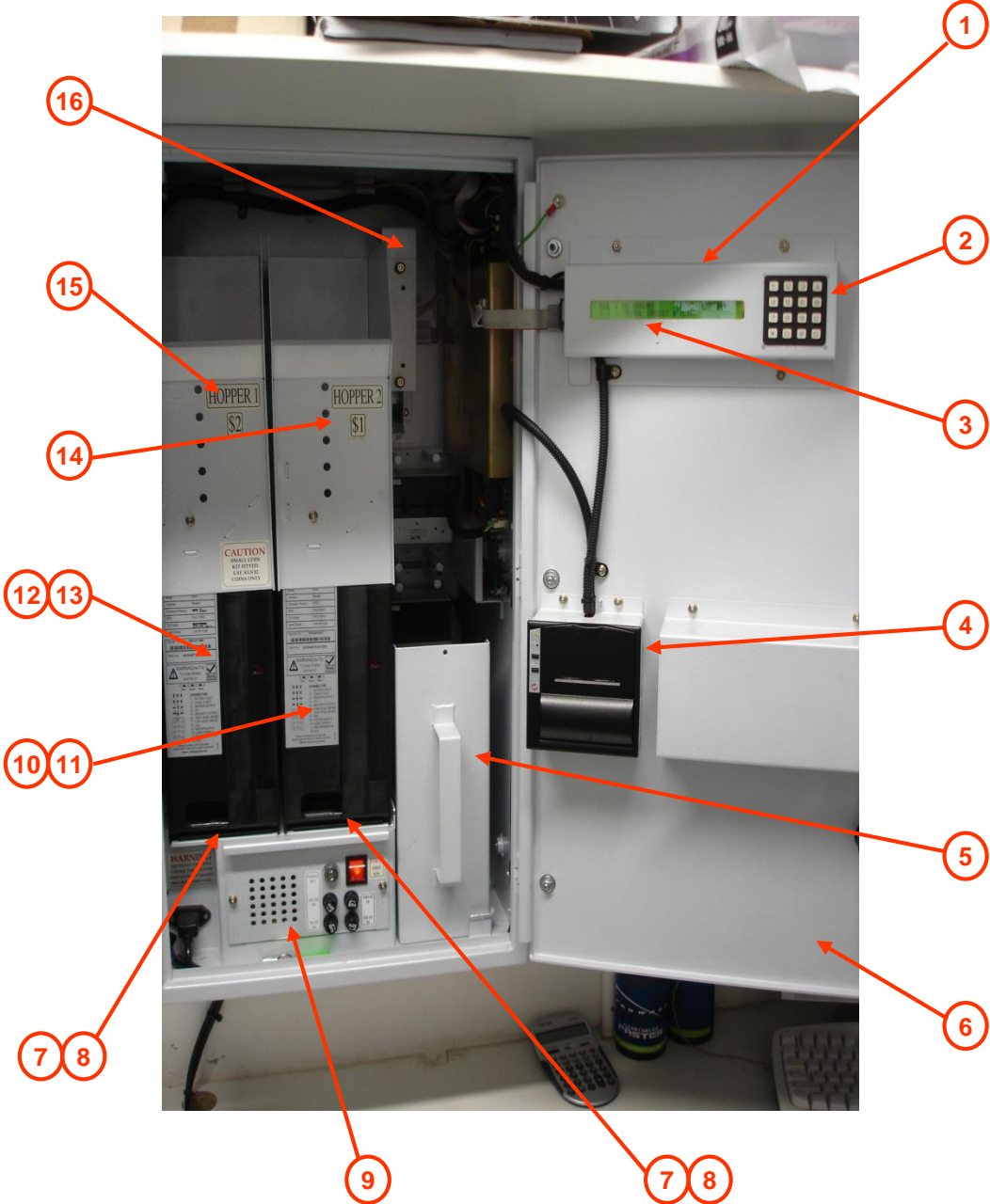

## QC5502 Change Machine Internal – Parts List

ITEM	PART#	DESCRIPTION
1	QCOPANEL	Keypad & Screen, Operator Panel (5500/5502)
2	QCKEYPAD	Keypad, Operator (5500/5502)
3	QCCUSTLCD	Screen, Customer Display (5500/5502)
4	QC5502PTR	Printer (QC5502)
5	QC5502BIN	Money Bin (QC5502)
6	QC5000LOCK	Rear Locks & 2 Keys (QC5000) (Not Shown)
7	QCMK2SLIDE	Hopper Slide, MK 2 Conversion (Not Shown)
8	QCMK4SLIDECHG	Hopper Slide Change Machine MK 4
9	QC5502PUP	Power Supply (QC5502)
10	QCMK45000-01	Coin Hopper Change Machine - \$1 MK 4
11	QCMK25000-01	Coin Hopper Change Machine - \$1 MK 2 (Not Shown)
12	QCMK45000-02	Coin Hopper Change Machine - \$2 MK 4
13	QCMK25000-02	Coin Hopper Change Machine - \$2 MK 2 (Not Shown)
14	QC5000SHUTE1	Extended Coin Chute \$1 coins
15	QC5000SHUTE2	Extended Coin Chute \$2 coins
16	MC93367810A	Microcoin QL Coin Acceptor for Change Machine (Top Entry)

## Change Mach. (QC5000/QC5500/QC5502) - Spare Parts List

PART#	DESCRIPTION
QC5000BIN	Money Bin (QC5000)
QC5000BINDOOR	Money Bin Door, Lock & Keys (QC5000)
QC5000GBA	Change Machine \$2 & \$1 (QC5000)
QC5000LCD	Screen, Operator Display (QC5000)
QC5000LOCK	Rear Locks & 2 Keys (QC5000)
QC5000LOGIC	Logic Board for QC5000 Only
QC5000LOOM	Complete Wiring Loom (QC5000)
QC5000PSUP	Power Supply, QC5000 MK 1 (Small)
QC5000PSUP2	Power Supply, QC5000 MK 2 (Big)
QC5000RIB	Ribbon Cables, Set of 3 (QC5000)
QC5000SCC	Steeper Coin Chute (QC5000)
QC5000SHUTE1	Extended Coin Chute \$1 coins
QC5000SHUTE2	Extended Coin Chute \$2 coins
QC5000SHUTE3	Standard Coin Chute \$1 coins
QC5000SHUTE4	Standard Coin Chute \$2 coins
QC5000SHUTE5	Change Chute (QC5000)
QC5500GBA	Change Machine \$2 & \$1 (QC5500)
QC5500HOP1	Cable, Hopper 1 \$2 coins (QC5500)
QC5500HOP2	Cable, Hopper 2 \$1 coins (QC5500)
QC5500PTRBKT	Printer Bracket (QC5500)
QC5502BACKP	Backplane Board (QC5502)
QC5502BIN	Money Bin (QC5502)
QC5502CAB1	Ribbon Cable 14 way int LCD-Logic 420mm (QC5502)
QC5502CAB2	Ribbon Cable 14 way OS LCD-Logic 700mm (QC5502)
QC5502CHUTE	Coin Chute (QC5502)
QC5502DOOR	Door Complete (QC5502)
QC5502GBA	Change Machine \$2 & \$1 w/Dual Note Acceptor (QC5502)
QC5502HOP1	Cable 20 Way Hopper 1 \$2 coins (QC5502)
QC5502LOGIC	Logic Board Complete QC5502 (2 Boards & Mounting Frame)
QC5502LOGICBARE	Logic Board Only with Eprom (QC5502)

## Change Mach. (QC5000/QC5500/QC5502) – Spare Parts List

PART#	DESCRIPTION
QC5502PSUP	Power Supply (QC5502)
QC5502PTR	Printer (QC5502)
QC5502RS232	Lead, RS232 (QC5502)
QC5600GBA	Note Changer Printer (Star)
QCCUSTLCD	Screen, Customer Display (5500/5502)
QCDOORSW	Door Switch (5500/5502)
QCGBALOOM	Loom GBA Logic (QC5502)
QCGBASG	Note Acceptor Anti String Gate
QCKEYPAD	Keypad, Operator (5500/5502)
QCMK25000-03	Note Changer Coin Hopper Slide Change Machine
QCMK2SLIDE	Hopper Slide, MK 2 Conversion
QCMK4SLIDECHANG	Coin Hopper Base Plate / Slide
QCMK4SLIDECHANGER	Coin Hopper Base Plate / Slide MK 4 (5000/5502)
QCMK4SLIDECHG	Hopper Slide Change Machine MK 4
QCOPANEL	Keypad & Screen, Operator Panel (5500/5502)
QCPCB10x10	PCB Adaptor 10 x 10
QCRELAY	Relay Board (QC5502)
QCRELAYCBLSET	Cable Set for Relay Board
QCRS232	Interface Board RS232 (5000/5500/5502)
QCRS232GBA	Lead, RS232 - GBA



## SECTION 10

# Vending Machines

- Single Column Electronic
- 3 Column Electronic
- 5 Column Electronic
- Vending Machine Decals
- Single Column Mechanical
- 5 Column Mechanical
- IVS Vend-it Vendor

**LAUREL**  
METAL PRODUCTS INCORPORATED

**Microcoin**<sup>®</sup>







# Single Column Drop Shelf Vendor - Electronic



ITEM	PART#	DESCRIPTION
1	VEOL399	Vendor, Single Column Electronic Drop Shelf (Includes QL Only)
2	DH23000	Abus Padlock
3	PW10401	Accepts \$1 & \$2 Coins Decal
4	PW10402	\$2 Decal
5	LP39919	Vendor, Single Column Electronic Drop Shelf Circuit Board
6	MC93367810	Microcoin QL Coin Acceptor (Top Entry )
7	LP2100-133L	Vendor, Single, 3 & 5 Electronic Drop Shelf Coin Tray, Lock & 2 Keys
8	LP30069	Vendor, Single Column Drop Shelf Coin Box No Lip
9	PW10403	\$3 Decal (Not Shown)

**Please see attached parts list for decal part numbers page 10-4**

## 3 Column Drop Shelf Vendor - Electronic

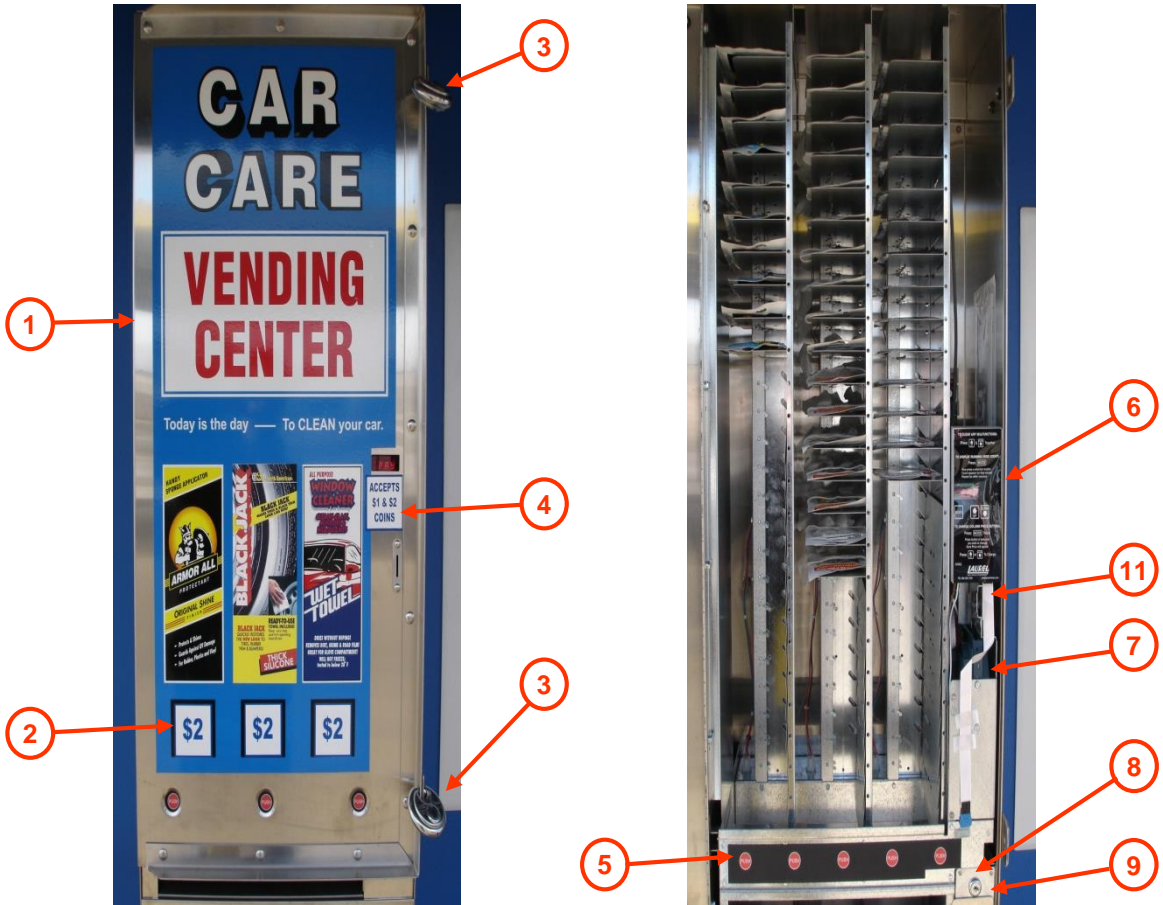

ITEM	PART#	DESCRIPTION
1	VE0L899	Vendor, 3 Column Electronic Drop Shelf (Includes QL Only)
2	PW10402	\$2 Decal
3	DH23000	Abus Padlock
4	PW10401	Accepts \$1 & \$2 Coins Decal
5	LP89920	Vendor, 3 & 5 Column Electronic Drop Shelf Switch Pad
6	LP89934	Vendor, 3 & 5 Column Electronic Drop Shelf Circuit Board
7	MC93367810	Microcoin QL Coin Acceptor (Top Entry)
8	LP2100-133L	Vendor, Single, 3 & 5 Electronic Drop Shelf Coin Tray, Lock & 2 Keys
9	LP21131	Vendor, 3 Column Electronic Drop Shelf Coin Box
10	PW10403	\$3 Decal (Not Shown)
11	LP59915	Cable Ribbon Electronic Vendor

**Please see attached part list for decal part numbers page 10-5.**

# 5 Column Drop Shelf Vendor - Electronic

Fragrance Tree Vendor

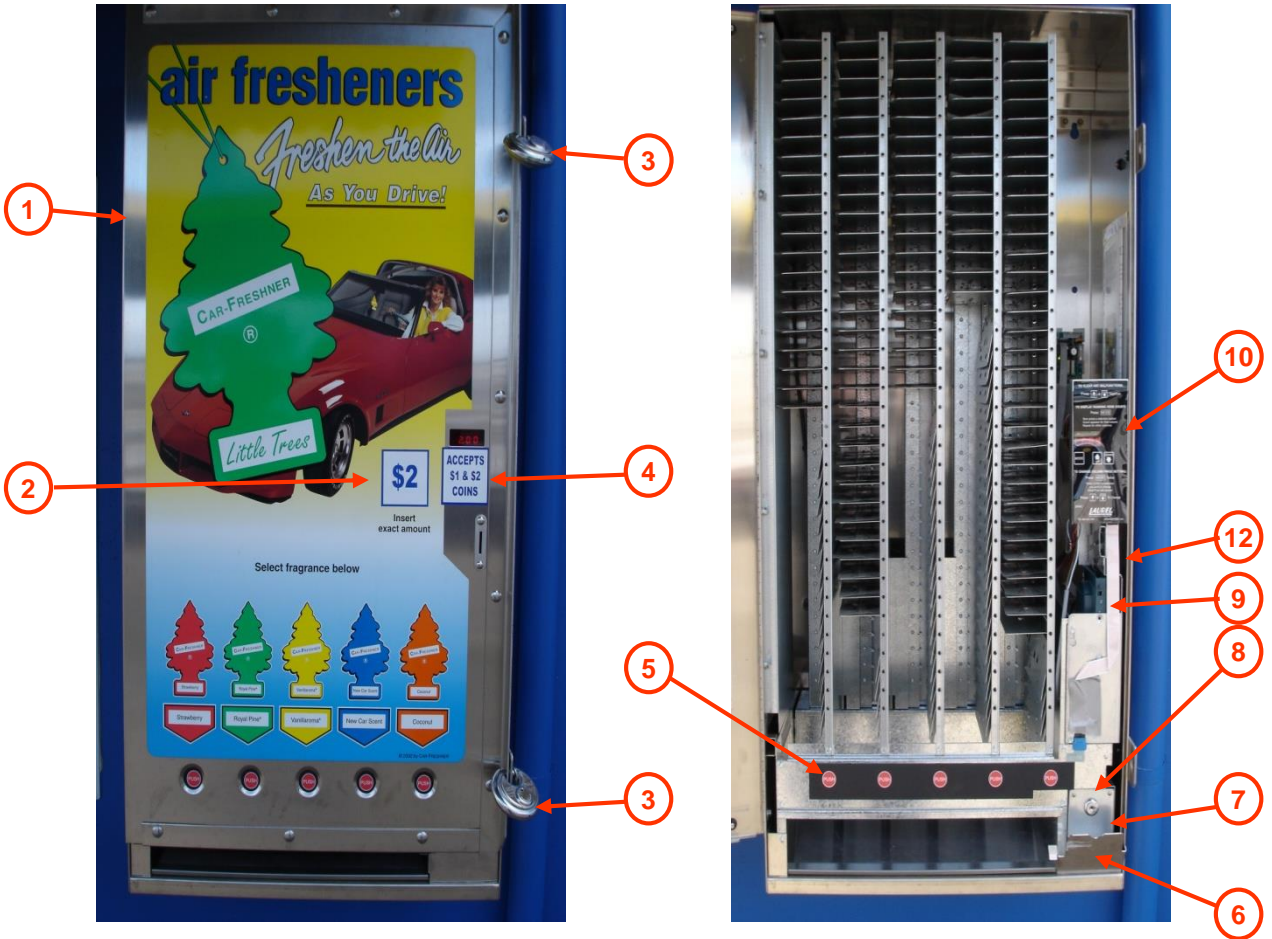

ITEM	PART#	DESCRIPTION
1	VE0L599	Vendor, 5 Column Electronic Drop Shelf (Includes QL Only)
2	PW10402	\$2 Decal
3	DH23000	Abus Padlock
4	PW10401	Accepts \$1 & \$2 Coins Decal
5	LP89920	Vendor, 3 & 5 Column Electronic Drop Shelf Switch Pad
6	LP3093	Vendor, 5 Column Drop Shelf Coin Box Door
7	LP30A79	Vendor, 5 Column Electronic Drop Shelf Coin Box
8	LP2100-133L	Vendor, Single, 3 & 5 Electronic Drop Shelf Coin Tray, Lock & 2 Keys
9	MC93367810	Microcoin QL Coin Acceptor (Top Entry)
10	LP89934	Vendor, 3 & 5 Column Electronic Drop Shelf Circuit Board
11	PW10403	\$3 Decal (Not Shown)
12	LP59915	Cable Ribbon Electronic Vendor

**Please see attached parts list for decal part numbers page 10-6.**

## Single Column Vendor Decals – Spare Parts List

PART#	DESCRIPTION
VPAA10800DEC	Armor All Protectant Sponge Decal
VPAA30800DEC	Armor All Multi Purpose Sponge Decal
VPBT100DEC	Blue Cloth Towel Decal
VPMF100DEC	Microfibre Towel Decal
VPNA1110DEC	Glass Cleaner Sachet Decal
VPNA1115DEC	Vinyl Plus Protectant Sachet Decal
VPNA1117DEC	Just For Leather Sachet Decal
VPNA1119DEC	Bug & Tar Remover Sachet Decal
VPNA1125DEC	Rain Vision Sachets Decal
VPNA1127DEC	Black Jack Sponge Decal
VPNA1128DEC	Never Fog Sachet Decal
VPNA3050BDEC	Thirsty Blue Towel Decal
VPSM100DEC	Simoniz Wheel Cleaner 4oz Decal
VPSM200DEC	Simoniz Tyre Shine 4oz Decal
VPSM300DEC	Simoniz Glass Cleaner 4oz Decal
VPQD100DEC	Quick Dry Cloth Towel Decal
VP184DEC	Quick Dry Glass Cleaner with Towel Decal
VE0139	Vendor Single Column Tree Decal
VP30001DEC	Wet Towel Sachet Decal

## 3 Column Vendor Decals – Spare Parts List

PART#	DESCRIPTION
VP30001OVL	Wet Towel Sachet Overlay
VPAA10800OVL	Armor All Protectant Sponge Overlay
VPAA30800OVL	Armor All Multi Purpose Sponge Overlay
VPBT100OVL	Blue Cloth Towel Overlay
VPMF100OVL	Microfibre Cloth Towel Overlay
VPNA1110OVL	Glass Cleaner Sachet Overlay
VPNA1115OVL	Vinyl Plus Protectant Sachet Overlay
VPNA1117OVL	Just For Leather Sachet Overlay
VPNA1119OVL	Bug & Tar Remover Sachet Overlay
VPNA1125OVL	Rain Vision Sachet Overlay
VPNA1127OVL	Black Jack Sponge Overlay
VPNA1128OVL	Never Fog Sachet Overlay
VPNA3050BOVL	Thirsty Blue Towel Overlay
VPQD100OVL	Quick Dry Cloth Towel Overlay
VPTW100WOVL	White Dry Pet Towel Overlay
VPTW166OVL	Sniffers Beef Pet Treat Overlay
VPTW250OVL	Kleen Pet Wash Mitts Overlay
VPTW251OVL	Kleen Pet Eye Wipes Overlay
VPTW252OVL	Kleen Pet Ear Wipes Overlay
VPTW253OVL	Kleen Pet Dental Wipes Overlay
VPVM2OVL	Condom 2 Pack Overlay
VE0160	3 Column Drop Shelf Vendor Car Care Decal
VPTW128DEC	3 Column Drop Shelf Vendor Dogwash Decal

## 5 Column Vendor Decals – Spare Parts List

PART#	DESCRIPTION
VE0118	5 Column Drop Shelf Vendor Decal
VP10101DEC	Royal Pine Fragrance Tree Decal
VP10102DEC	Bouquet Fragrance Tree Decal
VP10103DEC	Spice Fragrance Tree Decal
VP10105DEC	Vanillaroma Fragrance Tree Decal
VP10109DEC	Forest Fresh Fragrance Tree Decal
VP10155DEC	Black Ice Fragrance Tree Decal
VP10189DEC	New Car Fragrance Tree Decal
VP10221DEC	Ocean Mist Fragrance Tree Decal
VP10247DEC	Peppermint Fragrance Tree Decal
VP10311DEC	Wild Cherry Fragrance Tree Decal
VP10312DEC	Strawberry Fragrance Tree Decal
VP10313DEC	Lemon Fragrance Tree Decal
VP10316DEC	Green Apple Fragrance Tree Decal
VP10317DEC	Coconut Fragrance Tree Decal
VP10318DEC	Cinnaberry Fragrance Tree Decal
VP10319DEC	Peachy Peach Fragrance Tree Decal
VP10433DEC	Jasmine Fragrance Tree Decal
VP10918DEC	Rainbow Rush Fragrance Tree Decal
VP10942DEC	Summer Surf Tree Decal
VP10967DEC	Pina Colada Fragrance Tree Decal
VP11755DEC	Victory Lane Tree Decal
VP13443DEC	Berries 'n Spice Fragrance Tree Decal

# Single Column Drop Shelf Vendor - Mechanical



ITEM	PART#	DESCRIPTION
1	VE0201LM	Vendor, Single Column Mechanical Drop Shelf (No Padlocks)
2	LP21126	Vendor, Drop Shelf Coin Insert Plate
3	LP30069	Vendor, Single Column Drop Shelf Coin Box No Lip
4	LP21101	Vendor, Single Column Mechanical Drop Shelf Coin Mechanism
5	LP2132	Vendor, Mechanical Drop Shelf Knob
6	LP2131	Vendor, Mechanical Drop Shelf Pull Rod
7	LP21119	Vendor, Mechanical Drop Shelf Coin Return Button
8	DH23000	Abus Padlock (Not Shown)

## 5 Column Drop Shelf Vendor - Mechanical

Fragrance Tree Vendor



ITEM	PART#	DESCRIPTION
1	VE0206LM	Vendor, 5 Column Mechanical Drop Shelf (No Padlocks)
2	LP21126	Vendor, Drop Shelf Coin Insert Plate
3	LP2131	Vendor, Mechanical Drop Shelf Pull Rod
4	LP2132	Vendor, Mechanical Drop Shelf Knob
5	LP3093	Vendor, 5 Column Drop Shelf Coin Box Door
6	LP30A79	Vendor, 5 Column Mechanical Drop Shelf Coin Box
7	LP30D36	Vendor, 5 Column Mechanical Drop Shelf Coin Mechanism
8	LP21119	Vendor, Mechanical Drop Shelf Coin Return Button
9	DH23000	Abus Padlock (Not Shown)



**IVS Vend-It Vendor**



**Front View**



**Front Internal View**

# IVS Vend-It Vendor Internal

**Microcoin QL and Logic PCB**



**Transformer**



**Coin Hopper**

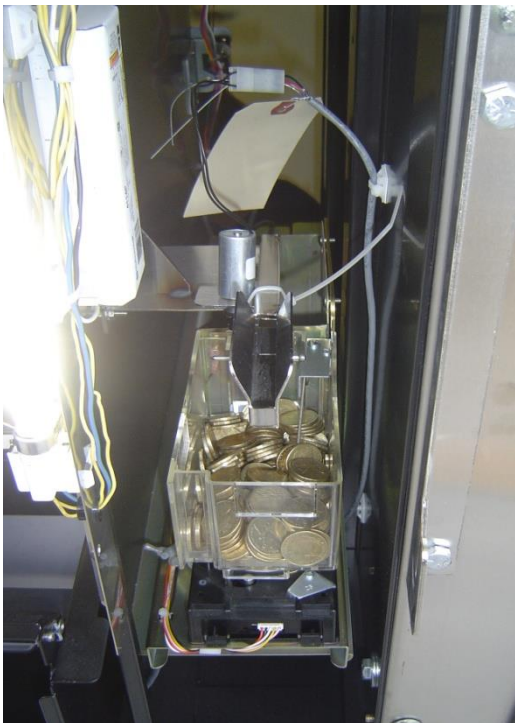

**Product Trays / Power Supply and Operator Module**

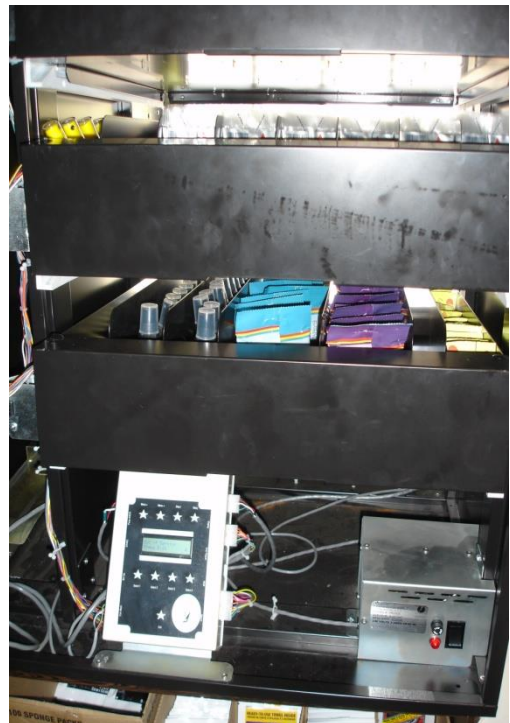

## SECTION 11

### SuperSat

- SuperSat System
- SuperSat L.E.D Upgrade Instructions
- Titration Test Procedure
- Titration Tip Size Chart





# SuperSat System



# SuperSat System

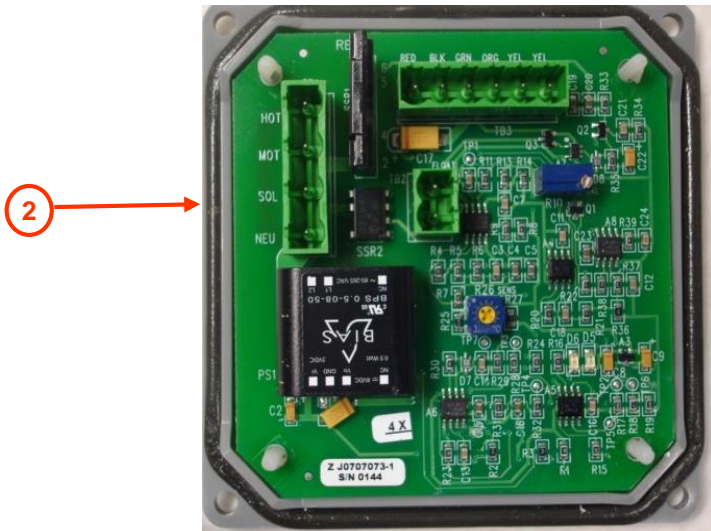
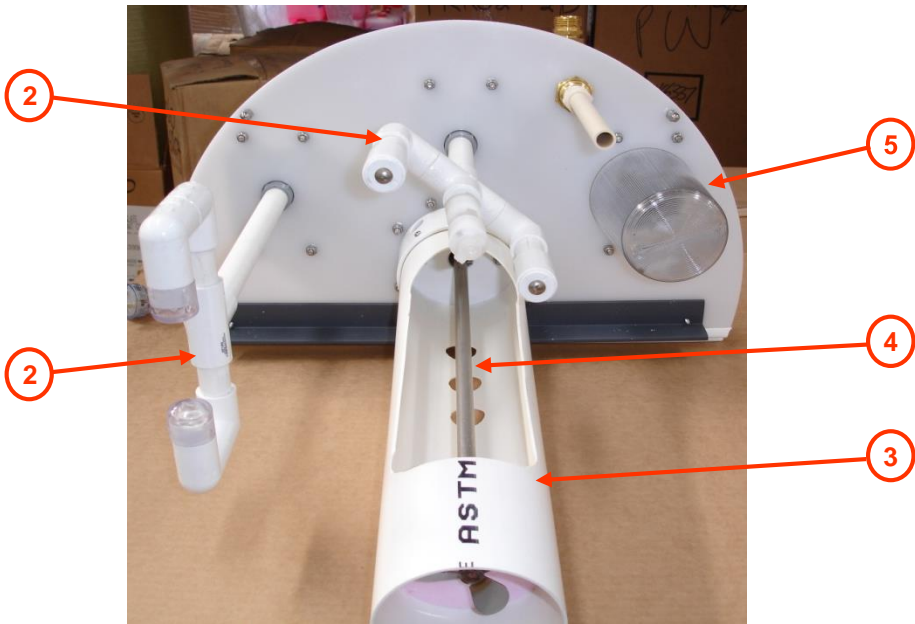
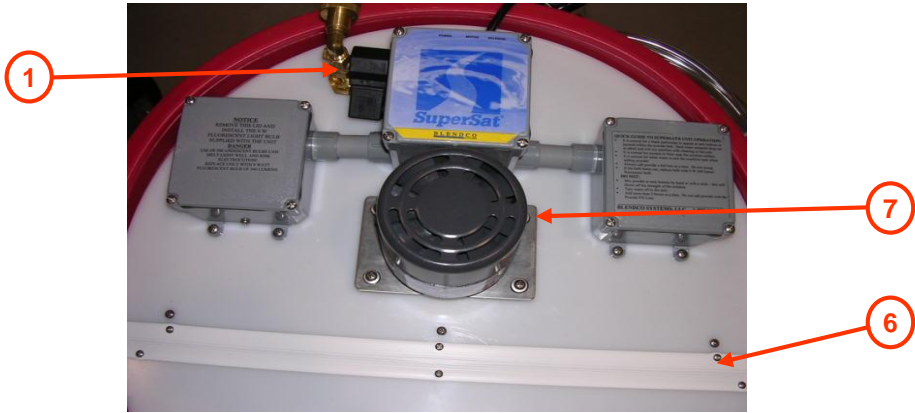

## SuperSat System – Parts List

ITEM	PART#	DESCRIPTION
1	SS7203	SuperSat Valve Solenoid 230V
2	SS7327	SuperSat L.E.D Upgrade
3	SS7124	SuperSat Tank Shaft Shield
4	SS7204	SuperSat Motor Shaft with 3 Blade Prop
5	SS7702	SuperSat Globe Bowl Cover
6	SS7082	SuperSat Hinge for Lid
7	SS7053	SuperSat Motor 240V

## L.E.D Upgrade Instructions

### Parts:

L.E.D printed circuit board with lid  
L.E.D lance and float assembly  
Mechanical backup float assembly

### Tools Needed:

Wire Cutter / Stripper  
Small flat head screw driver  
Pliers / Wrench

### Installation Procedure

- Unplug the 240VAC plug from 240VAC outlet.
- Orient the mixing assembly so the motor is closest to you.
- Remove the four screws from the centre and right side junction box cover plates.
- Disconnect all the terminals from the relays in the centre junction box (See Figure 1).
- Trace the black wire soldered to the relays to a wire nut in centre box and snip the black wire about 2 inches from wire nut. (This will be Hot lead).
- Loosen this wire nut and disconnect white float wire (see figure 2)  
\*For units with Mixing Control Circuit upgrade---
- Trace black wire from Mixing Control Circuit located in right box to centre box. Must be disconnected from wire nut.
- Tighten wire nut keeping remaining wires in place. Should be three black wires- one that goes to the fuse holder, another to the lamp, and the wire cut in above step (See Figure 3).
- Remove photocell and any assemblies and pull wires from the center box. Set this aside it will not be used (See Figure 4).
- Snip white jumper wire (this is the white wire with two connector leads that formerly went to relays) 4 inches from wire nut containing 4 white, 1 black wire (This will be Neutral lead). (See Figure 5).



## L.E.D Upgrade Instructions Cont.

- ❑ Snip off connection terminals from ends of motor and water solenoid wires. Strip all remaining wires to reveal 1/8 inch of copper wire. It is important that these wires not be stripped too long or they could potentially short on one another when steps are complete later. (See Figure 6).
- ❑ Wire the motor and solenoid wires to the corresponding “Mot”= motor and “Sol”= solenoid marked terminals on L.E.D pc board. These are the only two remaining black wires not connected to any wire bundle. The motor wire is the water solenoid.
- ❑ The L.E.D pc board has labels for where each should go at the point of connection. (See Figure 7).
- ❑ Wire the Hot (remaining black wire from 3 wire bundle) and Neutral leads (white wire coming off of 4 white/1 black bundle) to the corresponding “Hot” and “Neu”= neutral marked terminals on the L.E.D pc board. (See Figures 8 and 9).
- ❑ Replace photocell tube with new L.E.D lance. \* Note for older units where the old lance is glued in place you must cut the lance 2 inches from the lid bottom and use a PVC coupler to connect the lance with the old lance (see illustration below). The total distance from the lid bottom to the bottom of the lance should be 13 inches (See Figures 10 and 11).
- ❑ Feed L.E.D lance wires through PVC pipe into middle electrical box. Attach colored wires to the main terminal block- wire placement is noted in printing by color on the main control board. (See Figure 14).
- ❑ Remove old mechanical float assembly from middle electrical Box. Replace with new mechanical float supplied with upgrade kit. Attach both white wires to main circuit board near middle of control board. The two terminal block is green and has two screws for attaching each of the wires. This will be used as back up float switch for electronic float. (See Figure 15 ).

## L.E.D Upgrade Instructions Cont.

- ❑ Close up the boxes and be sure to get a tight seal of the box ensuring that a gasket is used between the box top and the box base. Plug the unit back in and confirm that all of the main functions are operational. A power indicator light should show on the middle electrical box and the light should be on. Lift the top from the unit (well above the level of the water). After a few seconds water should come in and the motor should begin mixing assuming the float is in the down position, with the float in the up position water should stop. Place your hand in between the L.E.D light and receiver on the L.E.D lance and hold it there for several seconds. The motor should stop mixing. If all the above checks out you can replace the lid for completion of the upgrade.
  
- ❑ Please note that the unit is set at the factory and the lance is matched to the L.E.D pc board. This ensures that the unit is set to mix to factory specifications. **DO NOT** change the setting on the unit unless after 2 or more hours the unit is not operating to target alkalinities. There is a variable resistor component (yellow dial) that can be turned **CLOCKWISE** for more mixing and **COUNTERCLOCKWISE** for less mixing. Factory settings are at 1:30 on the dial so to return to factory settings you can turn to this setting.

# L.E.D Upgrade Instructions Cont.

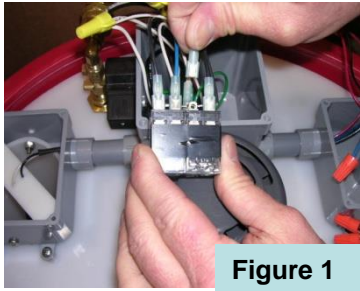

Figure 1

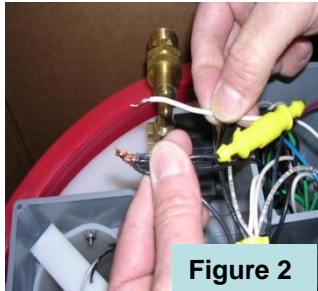

Figure 2

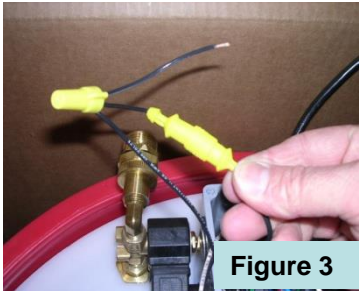

Figure 3

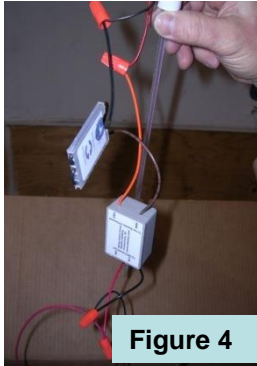

Figure 4

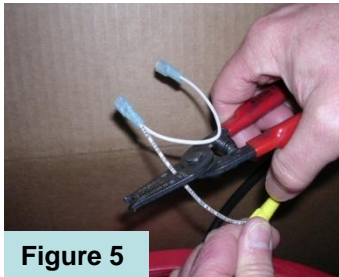

Figure 5



Figure 6

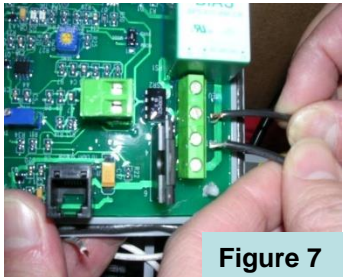

Figure 7

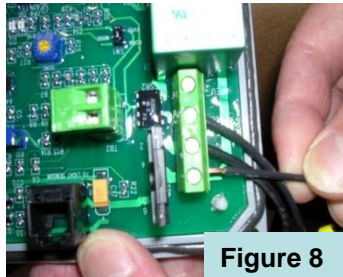

Figure 8



Figure 9

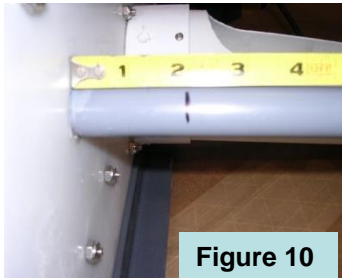

Figure 10

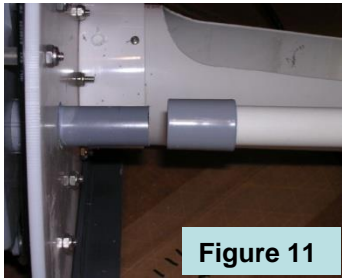

Figure 11

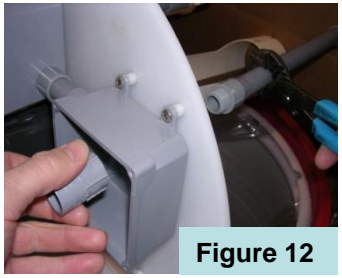

Figure 12

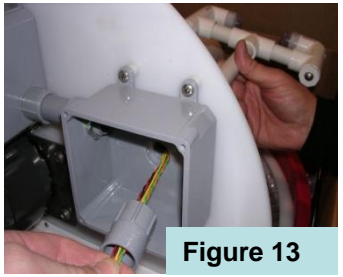

Figure 13

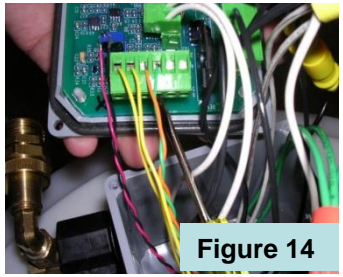

Figure 14

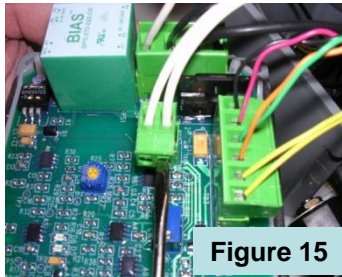

Figure 15

## SuperSat Titration Test Procedure

### Acid

1. Take sample of acid from arch.
2. Let solution settle until foam subsides.
3. Rinse the 10cc glass test tube with water or soap solution, then fill the tube with soap solution. (See Figure A).
4. Pour contents of tube (10cc) into 2oz plastic test tube. (Refer to Figure B)
5. Add two (2) drops of blue indicator solution. Sample should have a yellow tint. (See figure C).
6. Fill calibrated pipette with solution from the SuperSat tank (Alkaline) to the top calibrated mark. Hold it steady and do not let drops out or air to enter until tip is over test bottle.
7. Add alkaline until yellow colour disappears and soap solution returns to its original colour.
8. Count the amount of drops it takes to change the colour. This is the titration. (See Figure D).

### Alkaline

1. Take sample of alkaline from arch or soap tank.
2. Let solution settle until foam subsides.
3. Rinse the 10cc glass test tube with water or soap solution, then fill the tube with soap solution. (See Figure A).
4. Pour contents of tube (10cc) into 2oz plastic test tube. (Refer to Figure B)
5. Add two (2-4) drops of blue indicator solution. Sample should have a blue tint. (See Figure C).
6. Fill calibrated pipette with test acid to the top calibrated mark. Hold it steady and do not let drops out or air to enter until tip is over test bottle.
7. Add titration acid until blue colour disappears and soap solution returns to its original colour. Count the amount of drops it takes to change the colour. This is the titration (See Figure D).

**SuperSat Titration Test Procedure Cont.**

**Figure A**



**Figure B**



**Figure C**



**Figure D**



## SuperSat Titration Tip Size Chart

COLOUR	DIAMETER OF HOLE	DILUTION
Grey	0.128	5/1
Black	0.098	6/1
Beige (Very Light Brown)	0.07	8/1
Red	0.052	17/1
White	0.043	23/1
Blue	0.04	25/1
Tan (Medium Brown)	0.035	36/1
Green	0.028	48/1
Orange	0.025	64/1
Brown (Dark)	0.023	75/1
Yellow	0.02	90/1
Aqua	0.018	103/1
Purple	0.014	120/1
Pink	0.01	240/1
Clear	no hole	0

## SuperSat Titration Tip Colour (Recommendation ONLY)

FUNCTION	RECOMMENDED NUMBER OF DROPS	RECOMMENDED TIP COLOUR
Tyre & Engine Cleaner	40 - 45	Black
Presoak	10 - 15	Green
High Pressure Soap	15 - 20	Red
Foam Brush Tri Colour	5 - 8	Yellow

## SuperSat – Spare Parts List

PART#	DESCRIPTION
PW30071	SuperSat System 220V
SS7000	SuperSat Transformer 230V
SS7023	SuperSat Foot Valve
SS7051	SuperSat Float Switch Only
SS7052	SuperSat Float Switch
SS7053	SuperSat Motor 240V
SS7082	SuperSat Hinge for Lid
SS7100	SuperSat Photocell Lance Assembly
SS7104	SuperSat Light Well Assembly
SS7107	SuperSat Valve Anti Siphon
SS7109	SuperSat Pail Stinger Assembly
SS7114	SuperSat 1/4" Y Connector
SS7118	SuperSat Bottle Strainer
SS7121	SuperSat Orifice Tube 24"
SS7123	SuperSat Orifice Tube 48"
SS7124	SuperSat Tank Shaft Shield
SS7139	SuperSat Silicone Connector
SS7144	SuperSat Distributor Test Kit
SS7203	SuperSat Valve Solenoid 230V
SS7204	SuperSat Motor Shaft with 3 Blade Prop
SS7270	SuperSat Connector Tubing 1/4" x 1/4"
SS7280	SuperSat 1/2" Y Connector
SS7327	SuperSat L.E.D Upgrade
SS7701	SuperSat Photocell Mount Tube
SS7702	SuperSat Globe Bowl Cover
SS82696	SuperSat Connection Hose
SSEDUCT1	SuperSat Single Eductor
SSEDUCT2	SuperSat Dual Eductor





# SECTION 12

## Bonus Time

- Stand Alone
- Pump Stand Mount



# Bonus Time - Stand Alone

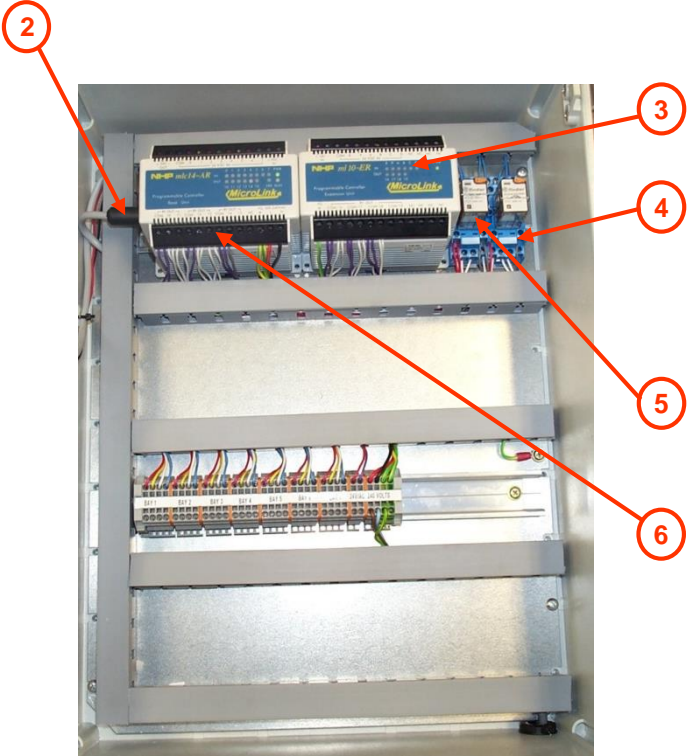
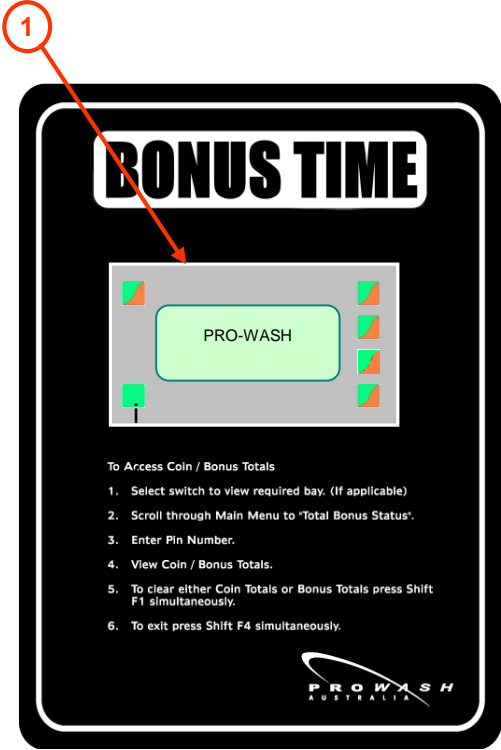

ITEM	PART#	DESCRIPTION
1	PW10077	Operator Panel LCD
2	PW10078	Microlink, Cable 25 Pin
3	PW10076	Microlink, PLC Expansion Unit
4	PW10084	Relay Base
5	PW10083	Relay 4 Pole 24VAC 7 Amp
6	PW10075	Microlink, PLC

## Bonus Time - Pump Stand Mount

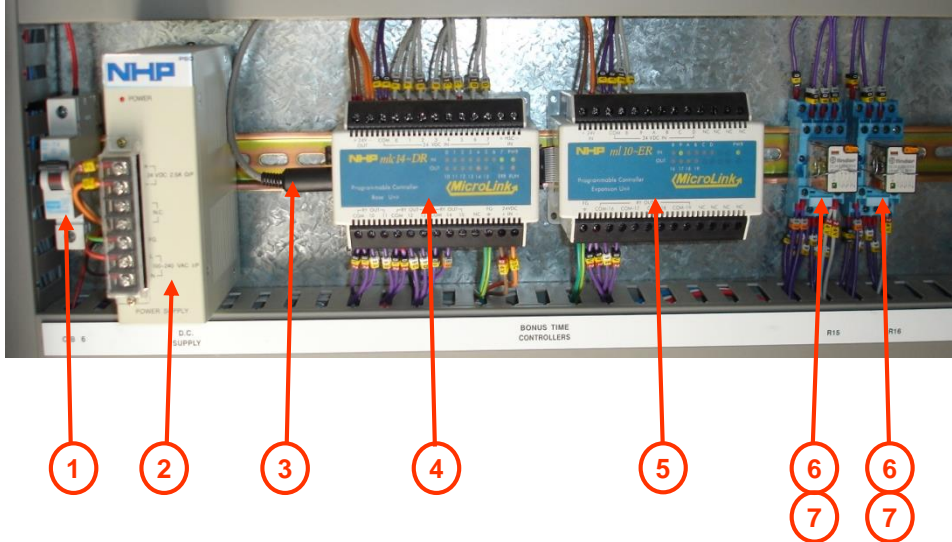

ITEM	PART#	DESCRIPTION
1	PWDINT6104C	Circuit Breaker 6kA Single Pole 4 Amp
2	PW10009	Microlink, Power Supply
3	PW10078	Microlink, Cable 25 Pin
4	PW10075	Microlink, PLC
5	PW10076	Microlink, PLC Expansion Unit
6	PW10084	Relay Base
7	PW10083	Relay 4 Pole 24VAC 7 Amp

**Please note:** If you do not have Item 2 you have a 240V Microlink PLC which is no longer available. You will need to purchase both a power supply (**Item 2**) and a new Microlink PLC (**Item 4**).

### Male Fittings

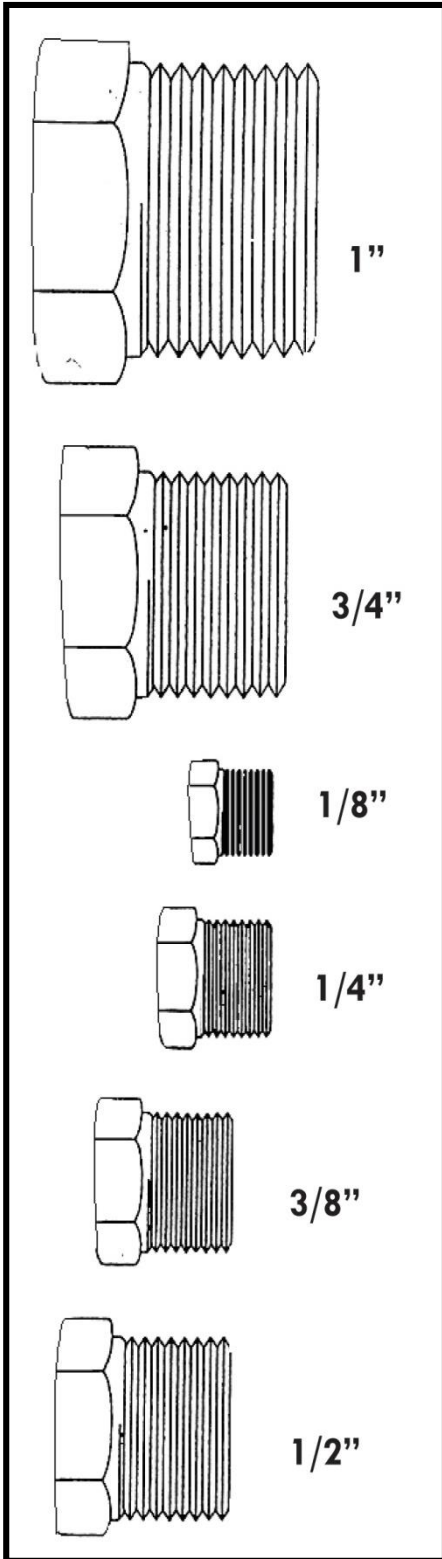

### Push-lok Hose Sizing

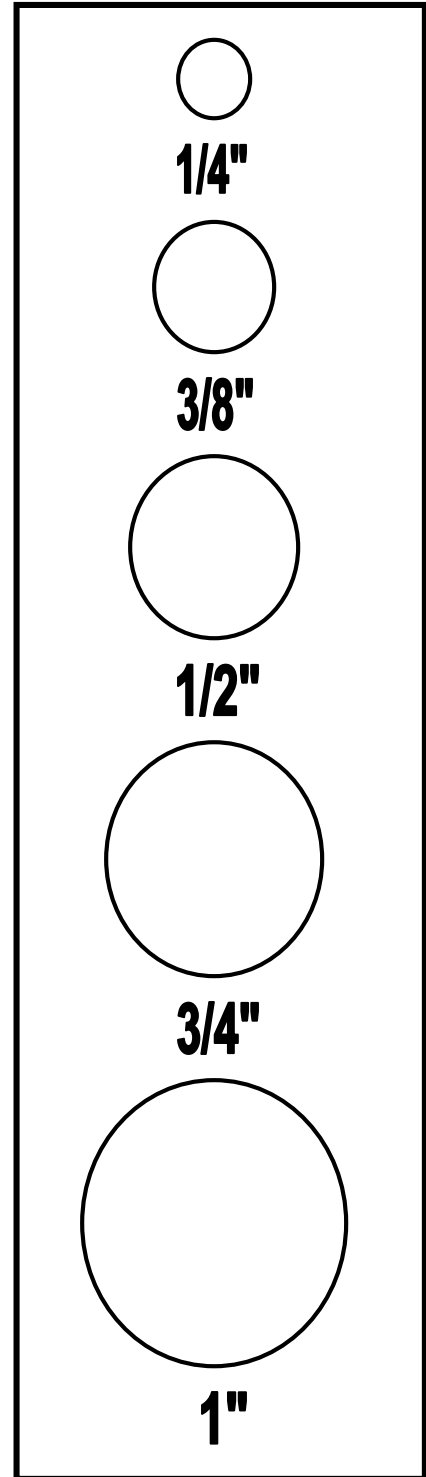

Hose measurements are for outside diameter

### Poly Tubing Sizing

